

# stryker®

## 1688 4K Camera System with Advanced Imaging Modality

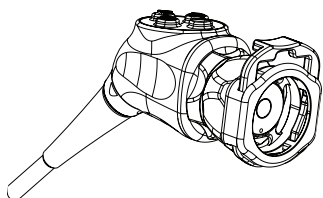

REF 1688010000

1688210105

1688310130

1688610122

1688710105

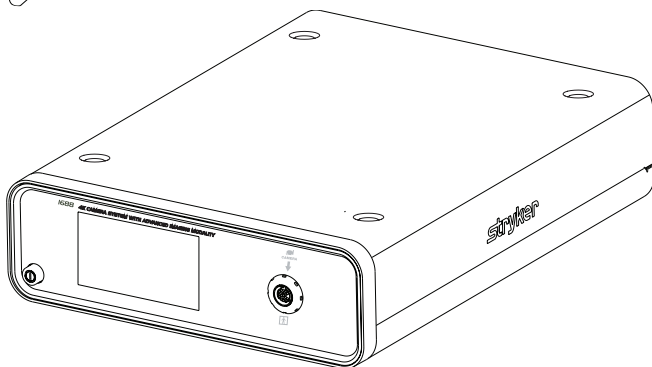

CE **R<sub>x</sub>** ONLY



# Contents

<b>Warnings and Cautions .....</b>	<b>1</b>
Cautions .....	1
Warnings: General .....	1
Warnings: SPY Mode.....	3
Operating a Light Source.....	4
<b>Product Description and Intended Use .....</b>	<b>5</b>
Indications.....	6
The Camera Console.....	7
The Camera Head .....	9
Additional Features of the Pendulum Camera Head .....	10
The C-Mount Coupler.....	12
Device Compatibility.....	13
<b>Setup .....</b>	<b>15</b>
Setting Up the Console .....	16
Wiring Diagram .....	18
Setting Up the Camera Head.....	19
Setting Up the Coupler.....	20
Installing the Soaking Cap .....	22
SPY Mode Requirements .....	23
<b>Operation .....</b>	<b>24</b>
Powering the Console On/Off.....	24
Performing the White Balance Test .....	24
Controlling Remote Video Accessories .....	25
Using the Touchscreen Interface.....	26
Using the Camera Head Buttons.....	30
Using the Display Monitor Menu .....	33
Programming Camera Head Buttons .....	36
Advanced Features.....	37
<b>Troubleshooting .....</b>	<b>38</b>
<b>Reprocessing.....</b>	<b>42</b>
Cleaning and Disinfecting the Console .....	42
Cleaning, Disinfecting, and Sterilizing the Camera Head .....	43
Materials and Equipment .....	45
<b>Maintenance .....</b>	<b>50</b>
Inspecting the Console.....	50

Inspecting the Camera Head.....	50
Using Sterile Drapes .....	51
Storage .....	51
Replacing the Fuses .....	51
Periodic Maintenance Schedule.....	52
Service Life .....	52
Disposal.....	52
Recycling Diagrams .....	53
<b>Technical Specifications .....</b>	<b>55</b>
Electromagnetic Compatibility.....	56
<b>Symbol Definitions .....</b>	<b>60</b>

# Warnings and Cautions

In this manual, the terms and definitions below apply.

- **Warning:** Possible injury to the patient or user.
- **Caution:** Possible damage to the equipment.
- **Note:** More information to clarify the instructions.

## Cautions

To avoid potential damage to this device, please note the following cautions.

1. Carefully unpack this device and check if any damage occurred during shipment. If damage is detected, refer to the warranty.
2. Never sterilize the camera console, because the delicate electronics cannot withstand this procedure.
3. Ensure that the electrical installation of the relevant operating room complies with the NEC and CEC guidelines.
4. Always treat the camera system with care. The camera system contains sensitive parts that are precisely aligned and may suffer damage if dropped or mistreated.
5. Repairs and equipment modifications shall be performed only by Stryker-authorized personnel. Stryker Endoscopy assumes no product liability or warranty responsibility for devices repaired by or purchased from third-party service organizations.

## Warnings: General

To avoid potential serious injury to the user and the patient and/or damage to this device, please note the following general warnings.

1. Federal (USA) law restricts this device to sale by or on the order of a physician.
2. Read this operating manual thoroughly, especially the warnings, and be familiar with its contents before connecting and using this device.
3. Although the product was fully tested at the factory before shipment, the user should always test it for proper function prior to a surgical procedure.
4. Always test that the endoscope produces a live, clear, correctly-oriented image prior to using it in a procedure and immediately after any viewing mode or setting is changed in the camera system.
5. The camera head surface may exceed 41 °C (106 °F) in operating conditions with high ambient temperatures and it should be handled with caution.

6. The camera head and coupler are shipped non-sterile. You must sterilize these devices before the first use and after each use. To prevent device damage and infection risk to the patient or user, follow all cleaning and sterilization instructions in this manual.
7. To minimize electromagnetic interference that may impact functionality of the 1688 Video Camera, position any active electrosurgical generator and its cables at least 12 inches (30 cm) away from the camera console. When the electrosurgical generator is placed on a boom with the camera console, it is advised to position the generator on the lowest shelf.
8. Do not position the console so that it is difficult to disconnect the power cord from the supply mains.
9. To avoid the risk of electric shock, this equipment must only be connected to a supply mains with protective earth ground.
10. Portable multiple socket-outlets shall not be placed on the floor. Additional portable multiple socket-outlets or extension cords shall not be used with the equipment.
11. Use of third-party HDMI cables with the camera console is not recommended due to potential problems with secure connections or electromagnetic compatibility. Use the provided HDMI high speed cable (or other Stryker-approved HDMI cable) with the camera console.
12. Never use the camera system in the presence of flammable or explosive gases or in an oxygen-rich environment.
13. To prevent tampering, physically secure the device when not in use.
14. Disconnect the console from the electrical outlet when inspecting fuses.
15. Do not remove covers on the console, as doing so may cause damage to electronics and/or electric shock.
16. Do not disassemble any part of the camera head; doing so may break the seals, causing leakage and/or electric shock.
17. Attempt no internal repairs or adjustments not specifically detailed in this operating manual.
18. Do not repair or adjust the device through a third-party service organization. Devices repaired by or purchased from third-party service organizations could expose patients to significant risk. These devices are no longer validated by Stryker for cleanliness, disinfection, and sterilization, or for safety and efficacy.

## Warnings: SPY Mode



### **IMPORTANT SAFETY NOTICE - LASER RADIATION:**

SPY mode controls a Class 1M laser emitted from the L11 LED Light Source with Advanced Imaging Modality (0220230300), also referred to as the “L11 LED Light Source.”

Use of controls or performance of procedures other than those specified herein can result in hazardous laser radiation exposure and can cause severe eye injury to the patient or user.

To avoid exposure to laser radiation, follow all warnings and guidelines presented below and throughout this user manual.

1. Before using SPY mode, read and be familiar with all instructions and warnings found in this user manual and the light source user manual.
2. Protect the camera system against unqualified use.
3. Wear eye protection as appropriate. Refer to any applicable regional regulations or standards for personal protective equipment.
4. Do not manipulate tissue while Contrast mode (a SPY mode) is on.
5. When using SPY mode, do not view the light output with optical instruments (for example, microscopes or magnifiers). Do not direct the light output in SPY mode into an area where such instruments are likely to be used.
6. Do not turn on SPY mode when the endoscope is outside of the patient’s body.
7. When SPY mode is on, never look into the following apertures or direct the light emitted from the apertures toward another person:
  - the light cable connection on the light source (if the cable is not attached)
  - the end of the light cable (if the SafeLight™ adapter is attached)
  - the endoscope tip
8. When SPY mode is on, never leave a SafeLight adapter attached to the light cable without an endoscope attached. Laser radiation can continue to emit from the adapter.
9. Disconnect the light cable from the light source only when the light source is powered off or the light output is deactivated.

## Operating a Light Source

Please note the following warnings to avoid user or patient injury or product damage when using a system with a light source. Note that the light source adjustments described apply only to operating the light source manually (i.e., with Auto Light off).



### **IMPORTANT SAFETY NOTICE - HIGH TEMPERATURES:**

When using a light source, fire and/or severe injury may result to the patient, user or inanimate objects if the instructions in this manual are not followed.

All light sources can generate significant amounts of heat (exceeding 41 °C/106 °F) at the scope tip, the scope light post, the light cable tip, and/or near the light cable adapter. Higher levels of brightness from the light source result in higher levels of heat. Always adjust the brightness level of the camera and the display monitor before adjusting the brightness level of the light source. If the brightness level of the light source can be adjusted, set it to the minimum brightness necessary to adequately illuminate the surgical site.

In addition, adjust the internal shutter of the camera higher in order to run the light source at a lower intensity. Avoid touching the scope tip or the light cable tip to the patient, and never place them on top of the patient, as doing so may result in burns to the patient or user. In addition, never place the scope tip, the scope light post, the light cable adapter, or the light cable tip on the surgical drapes or other flammable material, as doing so may result in fire.

Always deactivate the light output from the light source before removing the scope from the light cable or leaving the device unattended. The scope tip, scope light post, light cable adapter, and light cable tip will take several minutes to cool off after deactivating the light output, and therefore may still result in fire or burns to the patient, user, or inanimate objects.

The warranty is void if any of the above warnings or cautions are disregarded.



# Product Description and Intended Use

The 1688 4K Camera System with Advanced Imaging Modality (or “1688 Video Camera”) is an endoscopic camera system that is used to produce live video in the surgical field during surgical endoscopic procedures. The system is sensitive in the visible and infrared spectrum. The optical image is transferred from the surgical site to the camera head by a variety of rigid and flexible scopes, which are attached to the camera head. The system consists of a camera console and a camera head with an integral cable that connects to the console. A coupler is also available for attaching a scope to the camera head.

The available models for each part are listed below.

Console	
1688010000	1688 4K Camera Control Unit with Advanced Imaging Modality
Camera Heads	
1688210080	1688 4K Microscope Camera Head, C-Mount <sup>1,2</sup>
1688210105	1688 4K Camera Head, C-Mount, with Advanced Imaging Modality
1688310130	1688 4K Pendulum Camera Head with Integrated Coupler <sup>3</sup>
1688610122	1688 4K Camera Head, Integrated Coupler, with Advanced Imaging Modality
1688710105	1688 4K Inline Camera Head, C-Mount, with Advanced Imaging Modality
Coupler	
1688-020-122	4K Coupler, C-Mount, with Advanced Imaging Modality <sup>4</sup>

<sup>1</sup> Complete instructions are available in Stryker user manual P45082. Note that 1688210080 does not have the same intended use or indications as stated in this user manual.

<sup>2</sup> Not intended for use with SPY/ENV modes.

<sup>3</sup> Not compatible with SPY/ENV modes.

<sup>4</sup> Complete instructions are available in Stryker user manual P40880.

**Note:** For complete system requirements to use the camera’s SPY mode, see the user manual for the L11 LED Light Source with Advanced Imaging Modality (0220230300), also referred to as the “L11 LED Light Source.”

The camera console is also packaged with the following connection cables:

- Remote cables, 2.5 mm to 3.5 mm (Qty: 2)
- HDMI high speed cable (Qty: 1)
- Hospital-grade power cord (Qty: 1)

Contact your Stryker representative for availability of other cables that may be required for alternate configurations.

## **Indications**

The 1688 Video Camera is indicated for use in general laparoscopy, nasopharyngoscopy, ear endoscopy, sinuscopy, and plastic surgery wherever a laparoscope/endoscope/arthroscope/sinuscope is indicated for use.

A few examples of the more common endoscopic surgeries are listed below.

- laparoscopic cholecystectomy
- laparoscopic hernia repair
- laparoscopic appendectomy
- laparoscopic pelvic lymph node detection
- laparoscopically assisted hysterectomy
- laparoscopic and thorascopic anterior spinal fusion
- anterior cruciate ligament reconstruction
- knee arthroscopy
- small joint arthroscopy
- decompression fixation
- wedge resection
- lung biopsy
- pleural biopsy
- dorsal sympathectomy
- pleurodesis
- internal mammary artery dissection for coronary artery bypass
- coronary artery bypass grafting where endoscopic visualization is indicated
- examination of the evacuated cardiac chamber during performance of valve replacement

The users of the 1688 Video Camera are general surgeons, gynecologists, cardiac surgeons, thoracic surgeons, plastic surgeons, orthopedic surgeons, ENT surgeons and urologists.

## The Camera Console

The camera console—or Camera Control Unit (CCU)—is the control center for the 1688 Video Camera, and it processes the video and photographic images produced during the surgical procedure.

### Front Panel

The console front panel features a touchscreen where different menus can be accessed. The touchscreen can be used to adjust camera settings (such as Brightness, Zoom Level, and White Balance), select surgical specialties that optimize camera performance for specific surgical procedures, and turn on SPY mode. The touchscreen also allows activation of remote outputs, which are commonly used with a Stryker digital capture console to record images and video.

See the Operation section for more information about using the front panel.

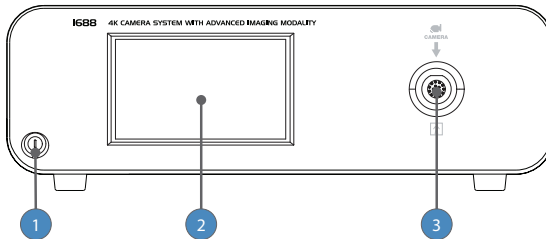

- |                                 |   |
|---------------------------------|---|
| <b>1. Power Switch</b>          | Powers the camera on and off  |
| <b>2. Touchscreen</b>           | Allows navigation through different menus for controlling the camera and adjusting the video settings |
| <b>3. Camera-Connector Port</b> | Connects to the 1688 Camera Head  |

## Rear Panel

The console rear panel provides ports for connecting the 1688 Video Camera to other equipment such as a display monitor, a light source, and a device control console and/or digital capture console.

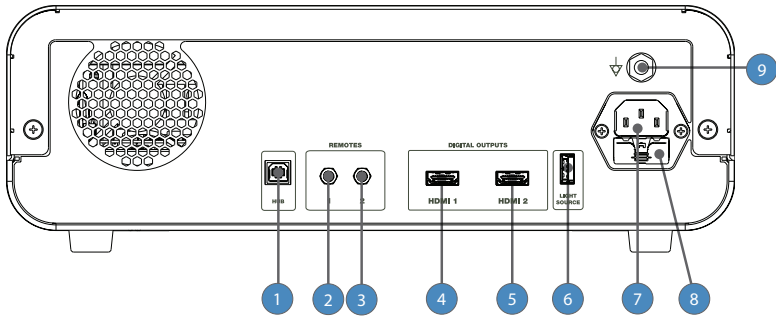

- 1. HUB Port** Connects to a Stryker device control console to enable voice operation and/or graphic tablet control
- 2. Remote Out 1** Connects to a video accessory remote input
- 3. Remote Out 2** Connects to a video accessory remote input
- 4. HDMI Out 1** HDMI 2.0 output (supports 4K UHD video resolution)
- 5. HDMI Out 2** HDMI 2.0 output (supports 4K UHD video resolution)
- 6. Light Source Port** Connects to Stryker light source
- 7. AC Power Inlet** Connects to AC mains with separable power cord
- 8. Fuse Panel** Contains two 1.6A 250V fuses (slow blow, high breaking capacity 1500A, size 5 mm x 20 mm)
- 9. Equipotential Ground Plug** Connects to a potential equalization conductor. The resulting medical electrical system shall follow all applicable IEC 60601-1 requirements.

## The Camera Head

The camera head connects to the camera console and produces video and photographic images, which it relays to the camera console. Several controls are accessible through a button keypad located on the top of the camera head (see the Operation section).

See the Product Description section for the different camera head models that are available. The 1688 4K Camera Head, C-Mount, with Advanced Imaging Modality (1688210105) is shown below with a list of features that are common to each camera head.

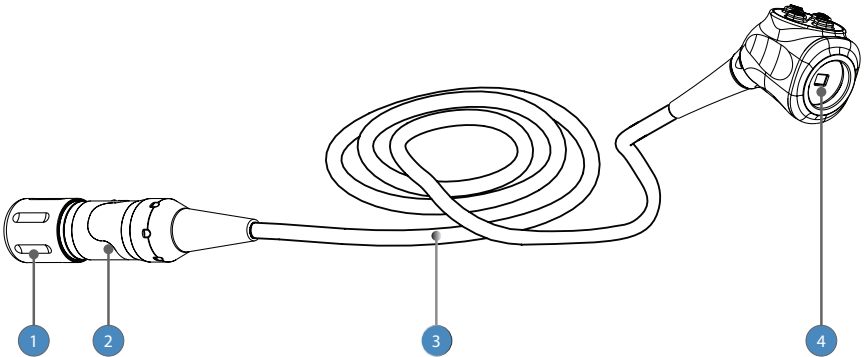

- 1. Soaking Cap** Protects the cable connector during cleaning, disinfection, and sterilization
- 2. Cable Connector** Connects the camera head to the camera console
- 3. Camera Cable** The camera cable length is 10 feet (3.05 m)
- 4. Camera Head** Produces photographic and video images, provides camera controls, and connects with (1688210105 and 1688710105) or integrates (1688310130 and 1688610122) a focusing coupler.

## Additional Features of the Pendulum Camera Head

The 1688 4K Pendulum Camera Head with Integrated Coupler (1688310130) utilizes each of the features described in the previous section, The Camera Head, and it has additional features that are described below.

The Pendulum Camera is designed with a 90° angle between the camera head and the scope to allow for easier access during urological procedures. The camera also incorporates image focusing and rotation features described in the following sections.

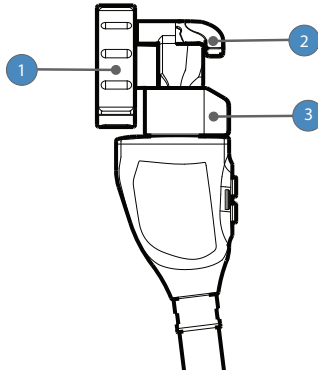

- 1. Endobody Clamp** Secures the endoscope to the camera head
- 2. Endobody Brake** Prevents rotation of the endoscope
- 3. Focusing Knob** Adjusts the focus of the camera head

### Adjusting the Focus (1688310130 only)

To adjust the focus of the Pendulum Camera Head, slide the focusing knob <sup>1</sup> from side to side as needed (i.e., in the direction of the Camera button or the Menu button).

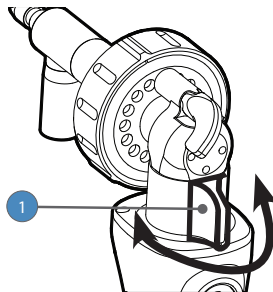

### Rotating the Image (1688310130 only)

To allow rotation of the endoscope inside the endobody clamp, release the endobody brake **1** by rotating it counterclockwise (when facing the camera head buttons). The endoscope can then be rotated as needed **2**.

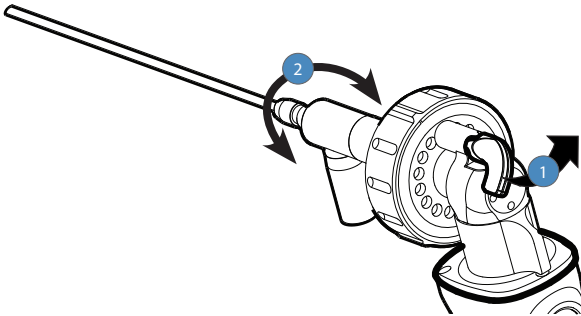

To prevent the endoscope from rotating inside the endobody clamp, lock the endobody brake by rotating it clockwise (when facing the camera head buttons). If the endoscope is not secured in a fixed position, slightly rotate the endobody clamp in either direction until the lock engages with an audible click.

### Automatic Image Flip (1688310130 only)

By default, the Pendulum Camera Head will automatically flip the video image back to the initial orientation when the camera is rotated 180°.

1. Hold the camera head with the endoscope axis parallel to the ground **1**.
2. Rotate the camera head from the “cable down” position **2** to the “cable up” position **3**. Once the camera head cable is fully rotated, the video image will rotate back to the initial orientation.

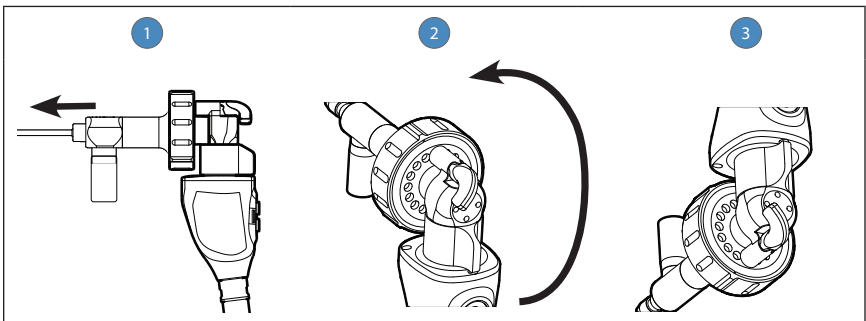

The video image will also flip when the camera head is rotated from the “cable up” position to the “cable down” position.

If you want to change the Pendulum Auto Flip setting, follow these steps:

1. Hold down the Settings button on the camera console Home screen for about 5 seconds.
2. Select Options.
3. Press the right arrow to advance to the second menu page, and change the Pendulum Auto Flip setting.
4. Click X in the top-right corner to return to the Home screen.

## The C-Mount Coupler

The coupler threads onto the face of the camera head, enabling a scope to be attached to the camera. It provides a focusing ring to adjust image sharpness.

It is recommended to use the camera with the 4K Coupler, C-Mount, with Advanced Imaging Modality (1688-020-122). The 4K Coupler enables use of SPY mode when the camera is connected to the the proper system. Refer to Stryker user manual P40880 for complete 4K Coupler instructions.

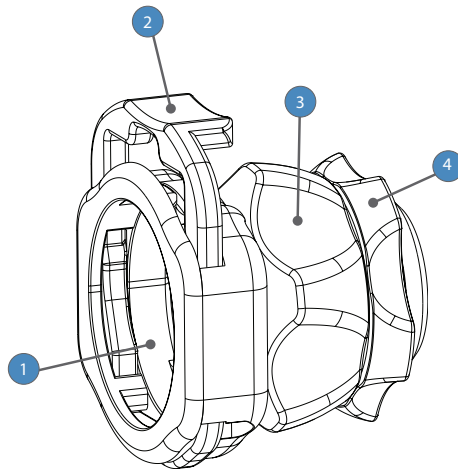

- |                          |                                  |
|--------------------------|----------------------------------|
| 1. <b>Scope End</b>      | Receives the endoscope           |
| 2. <b>Endobody Clamp</b> | Secures the scope to the coupler |
| 3. <b>Focusing Ring</b>  | Adjusts the coupler focus        |
| 4. <b>Rear Adapter</b>   | Threads onto the camera head     |



## Device Compatibility

For optimal use, the 1688 Video Camera is designed to work with the L11 LED Light Source (0220230300) and the Connected OR Hub (0240200100) with software version 1.2.1 or higher. All features and instructions described in this user manual apply to this system unless otherwise noted.

The 1688 Video Camera is also compatible with other light sources and digital capture devices that are listed below. The features and instructions that are different than the rest of this user manual are noted below. Please contact a Stryker representative for assistance with alternate system configurations.

<b>Alternate Light Sources</b>	
0220220300	<p>L10 LED Light Source with AIM Technology</p> <ul style="list-style-type: none"><li>• Connect to the camera console using the USB A-to-A cable provided with light source, P30883 (required to use ENV mode)</li><li>• Auto Light function is not available</li><li>• Overlay mode and Contrast mode (SPY modes) are not available (although ENV mode is still available)</li><li>• No camera control over ENV laser level (although the camera can control the Backlight level)</li><li>• No camera control over IRIS mode and settings</li><li>• Some display monitor menu options are not available (options that appear in grey)</li></ul>
0220220000	<p>Precision LED Light Source</p> <ul style="list-style-type: none"><li>• Connect to the camera console using the USB A-to-A cable provided with light source, P30883</li><li>• Auto Light function is not available</li><li>• SPY and IRIS modes are not available</li><li>• Some display monitor menu options are not available (options that appear in grey)</li></ul>
0220210000	<p>L9000 LED Light Source</p> <ul style="list-style-type: none"><li>• Connect to the camera console with a USB A-to-B cable</li><li>• No camera control of light levels (only activate/deactivate)</li><li>• Auto Light function is not available</li><li>• SPY and IRIS modes are not available</li><li>• Some display monitor menu options are not available (options that appear in grey)</li></ul>

## Alternate Digital Capture Device

0240060100

SDC3 HD Information Management System

- Send the video signal from the camera console to the SDC3 by connecting an HDMI-to-DVI adapter cable (P32235) from one of the camera console's HDMI outputs to one of the SDC3's DVI inputs
- Send the video signal from the SDC3 to a compatible display monitor by connecting a DVI cable from one of the SDC3's DVI outputs to an available DVI input on the display monitor
- The SDC3 does not have device control over the 1688 Video Camera or other devices that could be controlled by the camera head. (Although the user can still capture images and record video when SDC3 is connected to the camera console with remote cables.)
- The SDC3 is not designed to add device control options in the camera's display monitor menu.

# Setup

Stryker Endoscopy considers instructional training, or inservice, an integral part of the 1688 Video Camera. Your local Stryker Endoscopy sales representative will perform at least one inservice at your convenience to help set up your equipment and instruct you and your staff on its operation and maintenance. To schedule an inservice, contact your local Stryker Endoscopy representative after your equipment has arrived.

Setting up the 1688 Video Camera involves three steps:

- 1. Setting up the console**
- 2. Setting up the camera head**
- 3. Setting up the coupler**



- Always connect the console to an appropriate power source, using a hospital-grade power cord. Loss of AC power will cause the camera to shut down and the surgical image to be lost.
- Only connect items to the 1688 Video Camera that have been specified for use with the camera system. Connecting incompatible equipment may cause unexpected results.
- When the camera system is used with other equipment, leakage currents may be additive. Ensure that all systems are installed according to the requirements of IEC 60601-1.
- Equipment which employs RF communications may affect the normal function of the 1688 Video Camera. When choosing a location for the camera system, consult the Electromagnetic Compatibility section to ensure proper function.
- Always set up the console in a location that allows adequate ventilation (airflow) to the console. Insufficient ventilation may cause the console to overheat and shut down.

## Setting Up the Console

Refer to the following instructions and wiring diagram for a typical 1688 Video Camera configuration.

1. Using the provided power cord, connect the camera console's AC power inlet to a hospital-grade outlet.
2. Using the provided HDMI cable, connect the HDMI 1 output from the camera console to the HDMI 4K/HD IN 1 input on the Connected OR Hub (0240200100).
  - As a precaution against video loss related to the Connected OR Hub or primary display monitor, the camera console's second HDMI output can be connected directly to an HDMI input on an auxiliary display monitor.
3. Connect the HDMI 4K/HD OUT 1 output from the Connected OR Hub to the HDMI 4K input on the 32" 4K Surgical Display (0240-031-050).



For 4K camera resolution, the 1688 Video Camera shall be used with a 32" 4K Surgical Display that has firmware version 1.3.12 or higher. If not available, the camera resolution shall be operated in 1080p resolution. This setup is required to avoid degraded camera performance.

### **To determine the 32" 4K Surgical Display's firmware version:**

- a. Power on the Connected OR Hub and the 32" 4K Surgical Display. They must be connected, as described in step 3.
- b. Press the Specialty button on the display front panel.
- c. The firmware version is listed in the upper-right corner of the menu that appears. If the version is 1.3.12 or higher, proceed to step 4.

### **If the display firmware version is less than 1.3.12, follow these additional steps to operate the camera in 1080p resolution:**

- d. Power on the camera console.
- e. On the camera console Home screen, hold down the Settings button for about 5 seconds until the Advanced Settings screen appears.
- f. Press the Options button to go to the Options screen.
- g. Press the HDMI1 and HDMI2 output buttons to toggle from 4K to 1080p resolution.
- h. Click X in the top-right corner to return to the Home screen.

4. Using the provided remote cables, connect Remote outputs 1 and 2 from the camera console to Remote inputs 1 and 2 on the Connected OR Hub.
  - Devices connected to the remote outputs can be operated using the console touchscreen or the Camera button on the camera head. See the Operation section for details.
5. Connect a USB A-to-B cable from the HUB output on the camera console to an available Devices input on the Connected OR Hub. It is recommended to use the USB cable provided with the Connected OR Hub (0105-187-988), as use of third-party cables may prevent the devices from properly communicating.
  - Once connected to the 1688 Video Camera, the Connected OR Hub can control SPY mode and other camera functions. The user can also customize 1688 Camera Head button configurations through the Connected OR Hub. See the Connected OR Hub user manual for more details.
6. Connect a USB 3.0 A-to-B cable from the Light Source output on the camera console to the CCU input on the L11 LED Light Source (0220230300). It is recommended to use the USB cable provided with the Stryker light source (P40171), as use of third-party cables may prevent the devices from properly communicating.
  - To use SPY mode, the 1688 Video Camera requires a connection to the L11 LED Light Source.

Please contact a Stryker representative for alternate system configurations.

# Wiring Diagram

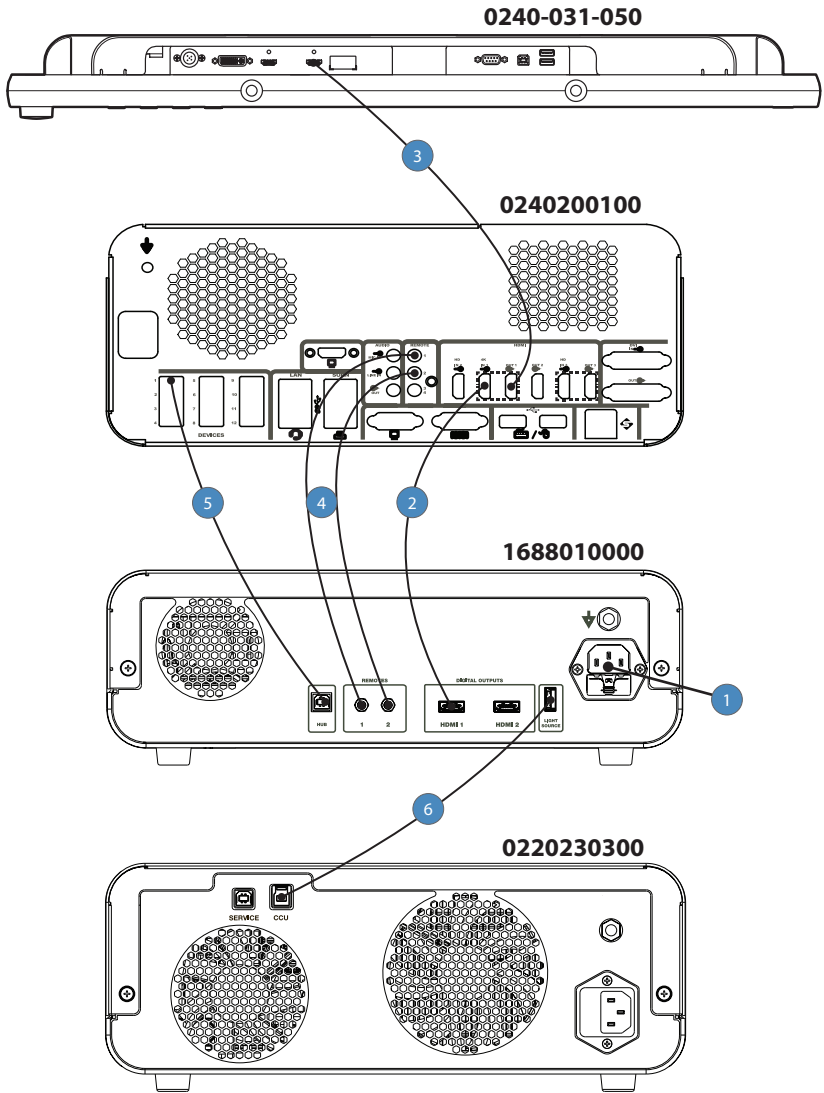

## Setting Up the Camera Head



Do not severely bend the camera cable or damage may result.

1. Unscrew the soaking cap from the cable connector on the camera head.
2. Align the arrow on the cable connector with the arrow above the camera-connector port on the front console panel.
3. Push in the connector until it locks in place.

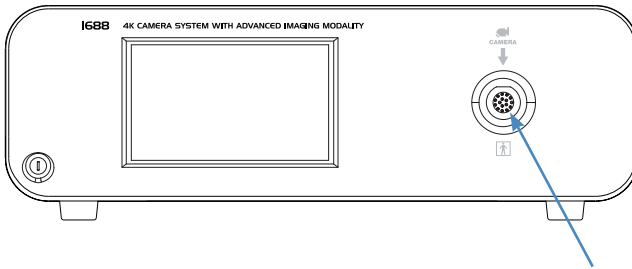

**Note:** To unplug the camera from the console, grasp the knobbed portion of the connector and pull straight out.

## Setting Up the Coupler

Steps 1–3 below provide instructions for connecting 1688 Camera Heads to the 4K Coupler, C-Mount, with Advanced Imaging Modality (1688-020-122) and to an endoscope and a light cable. Refer to the bullets below for possible system variations:

- When using the 1688 4K Pendulum Camera Head with Integrated Coupler (1688310130) or the 1688 4K Camera Head, Integrated Coupler, with Advanced Imaging Modality (1688610122), skip to step 2.
- When using a direct-coupled C-Mount endoscope (an endoscope that requires no coupler), thread the endoscope directly into the camera head until it forms a tight seal, and skip to step 3. (C-Mount endoscopes are not compatible with camera heads that have an integrated coupler.)



When attaching or removing the coupler, grip only the rear adapter, as twisting other parts of the coupler with force may result in mechanical damage.

Do not overtighten the coupler (or a direct-coupled C-mount endoscope), as this may damage the front window of the camera.

1. Attach the coupler to the camera head.
  - Gripping the rear adapter, screw the coupler clockwise onto the camera head until it forms a tight seal (1688210105 and 1688710105 only).

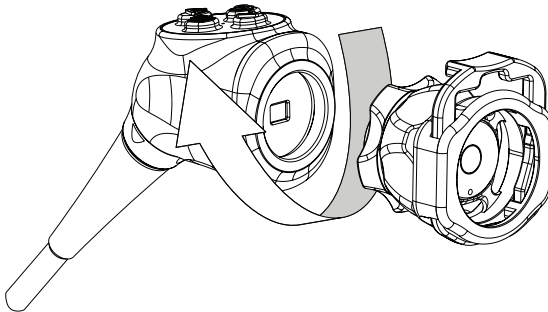

**Note:** To remove the coupler, grip the rear adapter and unscrew the coupler counterclockwise from the camera head.



2. Attach an endoscope to the coupler.



Before each use, check the outer surface of the endoscope to ensure there are no rough surfaces, sharp edges, or protrusions.

For 1688210105, 1688610122, and 1688710105:

**Note:** For a list of endoscopes that are compatible with SPY mode, see the user manual for the L11 LED Light Source.

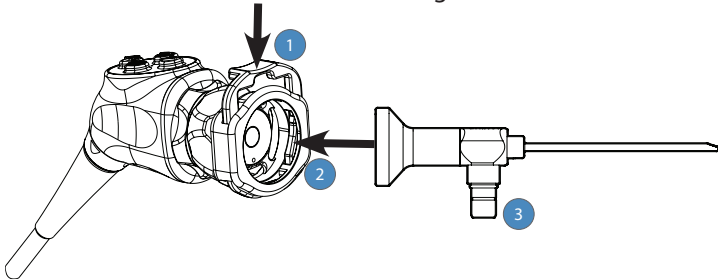

- Depress the endobody clamp 1 and insert an endoscope into the endobody 2 .
- Release the endobody clamp to secure the endoscope.

For 1688310130:

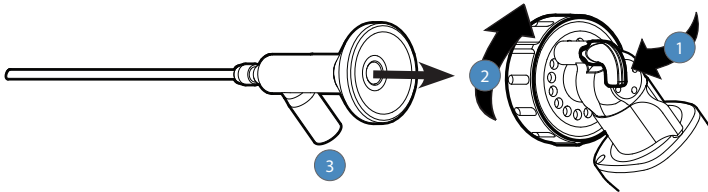

- Lock the endobody brake 1 by rotating it clockwise (when facing the camera head buttons).
- Twist the endobody clamp 2 as shown, and hold it open.
- Insert the endoscope into the endobody clamp.
- Release the endobody clamp. It will return to the original position and hold the endoscope.
- If the endoscope is not secured in a fixed position, slightly rotate the endobody clamp in either direction until the lock engages with an audible click.

3. Attach a light cable from the light source to the light post on the endoscope 3 .

**Note:** A scope adapter may be required to connect the cable to the endoscope. See the light cable user manual for more detail.

**Note:** Only the Stryker AIM SafeLight cable (0233-050-300) is compatible with SPY mode. SPY mode will not function if other cables are used. Refer to the AIM SafeLight cable user manual for complete cable instructions.



When connecting an AIM SafeLight cable to the endoscope, **always connect the scope adapter to the endoscope before connecting the adapter to the cable.** If SPY mode is on and the adapter is not connected to the scope, laser radiation will emit from the adapter that can cause severe eye injury to the patient or user.

## Installing the Soaking Cap

Before reprocessing the camera head, the soaking cap must be installed to avoid damaging the cable connector.

**Caution:** Failure to properly tighten the soaking cap will corrode the connector pins and void the warranty.

- To install the soaking cap, screw the cap onto the threads of the cable connector until it forms a tight seal.
- To remove the soaking cap, unscrew the cap and pull it away from the cable connector.

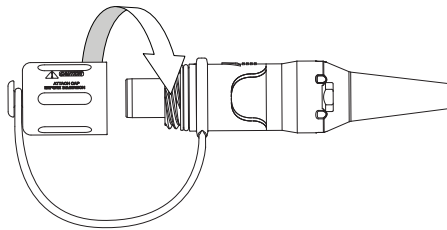

## SPY Mode Requirements

In SPY mode, the camera can visualize near-infrared light produced by the L11 LED Light Source (0220230300).



Before using SPY mode, be familiar with the Warnings: SPY Mode section of this user manual and all warnings and instructions in the light source user manual. Failure to follow all warnings can result in severe eye injury to the patient or user.

**Note:** For complete hardware and equipment requirements to use SPY mode, see the L11 LED Light Source user manual.

SPY mode will function properly on the 1688 Video Camera when the following conditions are met:

- A 1688 Camera Head is connected to the camera console (must be model 1688210105, 1688610122, or 1688710105)
- The Laparoscopy or Standard surgical specialty is selected on the camera console
- The camera console is connected to the L11 LED Light Source (using a USB 3.0 A-to-B cable provided with the light source)
- The light source is connected to an AIM SafeLight cable (0233-050-300)
- A SafeLight scope adapter is connected to the SafeLight cable (see the cable user manual for compatible adapter part numbers)
- Light output is activated from the light source
- Neither the White Balance screen or the camera head button configuration screen are present on the display monitor

Controls for SPY mode are accessible via the light source or the camera console touchscreen and camera head buttons. See the light source user manual or the Operation section of this user manual for more detail.

# Operation

**Note:** Before operating the device, ensure all system components have been set up according to the instructions in the Setup section.

## Powering the Console On/Off



Before using the camera in a surgical procedure, test all system components to ensure proper function. Ensure that a video image appears on all display monitors before beginning any procedure.

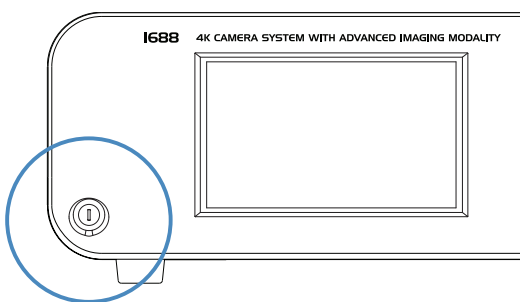

1. Power on the display monitor.
2. Press the power switch on the console to power the console on or off.

**Note:** A color bar pattern will appear on the display monitor if the camera head is not connected to the camera console. If the color bar appears, refer to the Setting Up the Camera Head section to connect the camera head.

## Performing the White Balance Test

Before each surgical procedure, perform the White Balance test to adjust the camera's perception of white so it can display other colors correctly.

When a camera head is connected to the console and the console is powered on, the display monitor will automatically prompt the user to perform the White Balance test.<sup>1</sup> Using the camera head buttons, follow the instructions on the display monitor to perform the test.

<sup>1</sup> English must be selected as the language in the Advanced Settings.

The White Balance test can also be performed after the camera head is already connected by pressing the WB button on the Home screen of the console (or a camera head button if it has been programmed for White Balance).

Follow the instructions below to perform the White Balance test:

1. Ensure that a scope, camera head, light source, and display monitor are connected to the camera system, and that the camera console, light source and display monitor are powered on.
2. Point the scope tip at several stacked white gauze pads, a white laparoscopic sponge, or any clean white surface.
3. Look at the display monitor and make sure there is no visible glare off of the white surface of the image.
4. Press the WB button on the Home screen (or press and quickly release a camera head button, if it has been programmed for White Balance) until "WHITE BALANCE IN PROGRESS" appears on the display monitor.
5. Continue pointing the scope at the white surface until "WHITE BALANCE COMPLETE" appears on the display monitor. The image may change color.

If you cannot achieve an acceptable White Balance, refer to the Troubleshooting section.

**Note:** The White Balance test is not available when SPY mode is on.

## Controlling Remote Video Accessories

When connected with the provided remote cables, the camera can remotely control up to two functions of a video accessory such as a Stryker digital capture console. Commonly this enables the user to capture images or start and stop video recording.

Remote video accessories can be controlled with the camera head's Camera button or the console touchscreen. See the following sections, Using the Touchscreen Interface and Using the Camera Head Buttons.

See the Setup section for instructions about connecting a video accessory to the console's Remote outputs.

## Using the Touchscreen Interface

The touchscreen interface on the console provides access to menus and controls for adjusting or capturing the video image. The features are described below.

### Navigation Bar

The Navigation Bar appears on the left side of each screen described in this Operation section. The currently selected screen is highlighted with a blue line in the Navigation Bar.



**Home:** Press the Home button to navigate to the Home screen.



**AIM:** Press the AIM button to navigate to the SPY screen.



**Settings:** Press the Settings button to navigate to the Camera Settings screen.

### Auto Light button

The Auto Light button appears in the bottom-right corner of each screen described in this Operation section. Press the button to toggle Auto Light on or off.

**Note:** To enable the Auto Light feature, the camera must be connected to the L11 LED Light Source and SPY mode must be off. Turning on SPY mode will disable the Auto Light feature.



**On (blue button):** Automatic adjustment of light settings on the light source to meet optimal light output.



**Off (black button):** Auto Light feature is off

## Home Screen

The Home Screen is the default screen. It displays the current surgical specialty and it provides access to common camera functions.

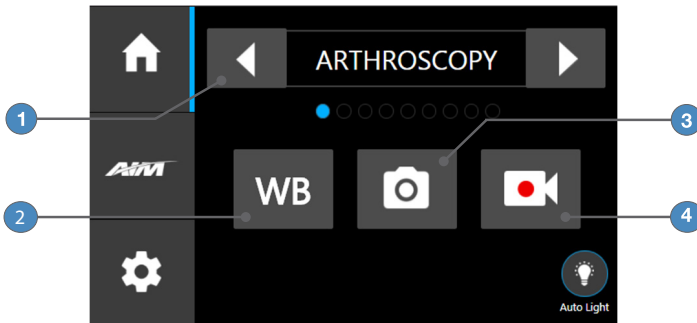

- 1. Surgical Specialty:** Use the arrows to scroll through surgical specialties that optimize camera performance for specific surgical procedures. Choose from:

- Arthroscopy
- Cystoscopy
- ENT/Skull
- Flexi-Scope<sup>1</sup>
- Hysteroscopy
- Laparoscopy
- Laser
- Microscope
- Standard

<sup>1</sup> When Flexi-Scope is selected, the following icon will appear in the top-left corner of the display monitor:



- 2. White Balance:** Press and briefly hold the WB button to activate the White Balance test. See the Performing the White Balance Test section for more detail.
  - ✓ A checkmark appears on the button after White Balance is completed successfully.
- 3. Picture:** Press the camera button to capture a photo.
  - ✓ A single beep will sound to indicate that a signal for capture/record has been sent to the digital capture console.
- 4. Record:** Press the record button to record a video. Press again to stop recording.
  - ✓ A double beep will sound to indicate that a signal for capture/record has been sent to the digital capture console.

## SPY Screen

SPY mode allows the camera to visualize near-infrared light produced by the L11 LED Light Source (0220230300). The SPY screen allows the user to adjust image settings within SPY mode.

**Note:** White Light must be activated on the L11 LED Light Source as a preliminary step to activate SPY mode.

See the SPY Mode Requirements section for required equipment and conditions to enable SPY mode.

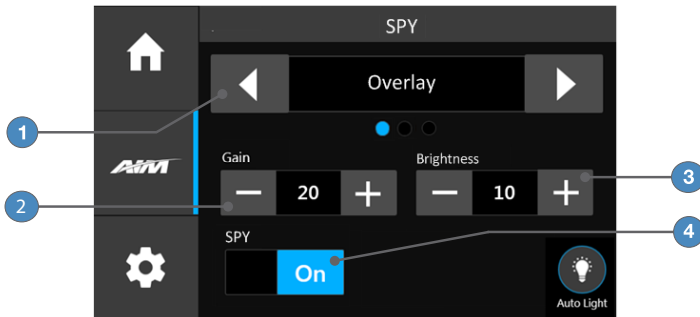

Before using SPY mode, be familiar with the Warnings: SPY Mode section of this user manual and all warnings and instructions in the light source user manual. Failure to follow all warnings can result in severe eye injury to the patient or user.

- 1. SPY Mode selection:** Press and briefly hold the arrows to scroll through the following SPY modes. The icon shown next to each SPY mode appears in the top-left corner of the display monitor when the mode is active.



(red, green, and blue)

- **Overlay:** The console outputs a white light image with ICG fluorescence indicated by the color green.



(all grey)

- **Contrast:** The console outputs an image with ICG fluorescence indicated by the color white. All other areas of the image appear dark.



(all green)

- **ENV:** The console outputs a greyscale white light image with ICG fluorescence indicated by the color green.



- Gain:** Press the plus or minus button to increase or decrease the SPY Gain level, which affects the fluorescing green appearance of the camera image. Range: 1-10.
- Brightness:** Press the plus or minus button to increase or decrease the brightness appearance of the white light image in SPY mode. Range: 1-8.
- SPY Mode On/Off:** Press and briefly hold the button to toggle SPY mode on or off.

## Camera Settings Screen

The Camera Settings screen provides options for adjusting the camera picture.



- Brightness:** Press the plus or minus button to increase or decrease the brightness level. Range: 1-8.
- Zoom:** Press the plus or minus button to increase or decrease the level of magnification. Range: 1-7.<sup>1</sup>

Note: As the Zoom level changes, the camera will optimize the image by automatically adjusting the Enhancement level.<sup>1</sup>

- Enhancement:** Press the plus or minus button to increase or decrease the enhancement level (the apparent sharpness of the image). Range: 1-8.

<sup>1</sup> Information provided is for software version 3.0.7 and higher. In previous software versions, the Zoom range is 1-5 and the camera does not automatically adjust Enhancement. The software version appears on the boot up screen, or the user can check by following these steps:

- On the console Home screen, hold down the Settings button for about 5 seconds until the Advanced Settings screen appears.
- Press the System button.
- Check the CCU version.
- Click X in the top-right corner to return to the Home screen.

## Using the Camera Head Buttons

The camera head features a four-button keypad for controlling the device.

**The default button functions are described below.**

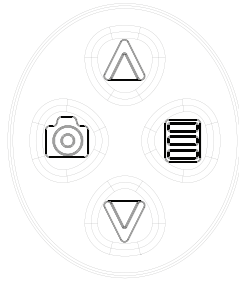

The camera head buttons can be customized differently for each surgical specialty. See the Programming Camera Head Buttons section for more detail.

The button configuration for the selected surgical specialty will appear on the display monitor when the camera head is connected to the console. The button configuration will disappear once any camera head button is pressed.





### Camera Button

The Camera button controls up to two functions of a remote video accessory. Commonly this enables the user to capture images or start and stop video recording. (See the Controlling Remote Video Accessories section for connection requirements.)

-  **Short press: Capture Photo.** Press and quickly release the Camera button to select Remote 1. One beep will sound. When the camera is connected to a Stryker digital capture console, this will capture a photo.
-  **Long press: Start/Stop Video Recording.** Press and briefly hold the Camera button to select Remote 2. Two beeps will sound. When the camera is connected to a Stryker digital capture console, this will start or stop video recording.

## Menu Button



The Menu button opens a display monitor menu with options for device control<sup>1</sup>, or (depending on the selected surgical specialty) it cycles through zoom levels or toggles SPY mode on and off.







- 
**Short press: Zoom Cycle** (in all surgical specialties except Laparoscopy and Standard). Press and quickly release the Menu button to increase the Zoom level. When the maximum Zoom level is reached, pressing the button again cycles to the minimum level.
- 
**Short press: SPY Toggle** (in Laparoscopy or Standard surgical specialty). Press and quickly release the Menu button to turn SPY mode on and off.
- 
**Long press: Open Menu.** Press and briefly hold the Menu button to open a Menu on the display monitor with image settings and device control options.<sup>1</sup> See the Display Monitor Menu section for detail.

<sup>1</sup> English must be selected as the language in the Advanced Settings.

## Up and Down Buttons

The up and down buttons change functionality depending on the conditions:

Conditions	Functionality of Up/Down buttons
<ul style="list-style-type: none"> <li>• Default</li> </ul>	<ul style="list-style-type: none"> <li>  <b>Short press: Brightness Level.</b>            Press and quickly release the up and down buttons to increase or decrease the brightness level in eight steps.         </li> <li>  <b>Long press: Lightsource Toggle.</b> Press and briefly hold the up button to toggle the light source between activating and deactivating light output.         </li> <li>  <b>Long press: Hub Function.</b> Press and briefly hold the down button to signal the device control console to perform an assignable command.         </li> </ul>

Conditions	Functionality of Up/Down buttons
<ul style="list-style-type: none"> <li>English selected as language</li> <li>Menu is open on the display monitor</li> </ul>	<ul style="list-style-type: none"> <li>   <b>Scroll list.</b> Press the up and down buttons to scroll up and down the list on the display monitor.         </li> </ul>
<ul style="list-style-type: none"> <li>SPY mode is on</li> </ul>	<ul style="list-style-type: none"> <li>  <b>Short press: SPY Image Cycle.</b> Press and quickly release the up button to activate the SPY Image Cycle function, which cycles through the SPY modes (Overlay, Contrast, and ENV). SPY mode must be turned on for Overlay, Contrast, or ENV mode to affect the video image.         </li> <li>  <b>Long press: Brightness Cycle.</b> Press and briefly hold the up button to activate the Brightness Cycle function. Each press raises the brightness level in eight steps; pressing it again cycles the level back to the lowest setting.         </li> <li>  <b>Short press: SPY Gain Cycle.</b> Press and quickly release the down button to activate the SPY Gain Cycle function, which uses the camera processor to adjust the fluorescing appearance of the camera image. Each press raises the SPY Gain level in eight steps; pressing it again cycles the level back to the lowest setting.         </li> <li>  <b>Long press: No function.</b> Pressing and briefly holding the down button in SPY mode has no function.         </li> </ul>

## Using the Display Monitor Menu

Press and briefly hold the Menu button to open a series of menus on the display monitor with image settings and device control options.<sup>1</sup> The menus are described below.

<sup>1</sup> English must be selected as the language in the Advanced Settings.

While the Menu feature is open, the camera head buttons will change function to navigate the menus and lists on the display monitor.

- The **up and down buttons** scroll up and down the list of options.
- The **Menu button** selects the highlighted option.
- The **Camera button** returns to the previous menu. At the top-level menu, pressing the Camera button again exits the Menu feature.

Some menu options will not be available if the console is not connected to the L11 LED Light Source. The options that are not available appear in grey.

When the console is connected to the Devices input on the Connected OR Hub, more options for device control will appear in the menus. Refer to the Connected OR Hub user manual for information about the additional options.

Top-Level Menu	Description
IMAGING MODES	Navigate to Imaging Modes menu
CAMERA SETTINGS	Navigate to Camera Settings menu
WHITE BALANCE	Start White Balance test

Imaging Modes Menu	Description
SPY	Navigate to SPY menu
AUTOLIGHT	Navigate to Auto Light menu
IRIS	Navigate to IRIS menu

Camera Settings Menu	Description
LIGHT SOURCE	Navigate to Light Source menu
ZOOM IN	Increase zoom level
ZOOM OUT	Decrease zoom level
SHUTTER AUTO	Sets the shutter to automatically adjust to the desired brightness without overexposing the image

SHUTTER MANUAL	Turns off automatic shutter (overall, image is more overexposed)
BRIGHTER	Increase brightness level
DARKER	Decrease brightness level

<b>SPY Menu</b>	<b>Description</b>
ON	Turn on SPY mode, which allows the camera to visualize near-infrared light
OFF	Turn off SPY mode
MODE	Navigate to SPY Mode menu
GAIN UP	Increase SPY Gain level, which uses the camera processor to adjust the fluorescing appearance of the camera image
GAIN DOWN	Decrease SPY Gain level, which uses the camera processor to adjust the fluorescing appearance of the camera image
BACKLIGHT UP	Increase Backlight level, which affects the brightness of surrounding anatomy in the camera image that is not displayed as fluorescing green (available only when used with the L10 LED Light Source)
BACKLIGHT DOWN	Decrease Backlight level, which affects the brightness of surrounding anatomy in the camera image that is not displayed as fluorescing green (available only when used with the L10 LED Light Source)

<b>Auto Light Menu</b>	<b>Description</b>
ON	Turn on the Auto Light feature, which automatically adjusts light settings on the light source to meet optimal light output.
OFF	Turn off the Auto Light feature

<b>IRIS Menu</b>	<b>Description</b>
ON	Turn on Infrared Illumination System (IRIS) mode on the light source, which enables use of the IRIS Ureteral Kit when connected to a compatible light source
OFF	Turn off IRIS mode
CONTINUOUS	Set the IRIS light output to continuous (the laser energy is continuous)
PULSATING	Set the IRIS light output to pulsating (the laser energy pulses in a repeating pattern of 0.5 second on/0.5 second off (1 pulse cycle/second))

<b>SPY Mode Menu</b>	<b>Description</b>
OVERLAY	Change the SPY mode to Overlay (the console outputs a white light image with ICG fluorescence indicated by the color green)
CONTRAST	Change the SPY mode to Contrast (the console outputs an image with ICG fluorescence indicated by the color white; all other areas of the image appear dark)
ENV	Change the SPY mode to ENV (the console outputs a greyscale white light image with ICG fluorescence indicated by the color green)

<b>Light Source Menu</b>	<b>Description</b>
ACTIVATE	Turn on white light from the light source
STANDBY	Deactivate light output from the light source
LIGHT UP	Increase the white light brightness on the light source
LIGHT DOWN	Decrease the white light brightness on the light source
AUTOLIGHT ON	Turn on the Auto Light feature, which automatically adjusts light settings on the light source to meet optimal light output.
AUTOLIGHT OFF	Turn off the Auto Light feature

## Programming Camera Head Buttons

The camera head buttons can be customized differently for each surgical specialty. **Contact a Stryker representative for assistance with button programming.**

The button configuration for the selected surgical speciality will appear on the display monitor when the camera head is connected to the console. The button configuration will disappear once the Camera button is pressed.

**Note:** The default up and down camera head button functions when SPY mode is on cannot be reconfigured.

The following functions can be programmed to the buttons:

Function Name	Function Description
AUTO LIGHT TOGGLE	Toggle the Auto Light function on/off
BACKLIGHT UP	Increase Backlight level, which affects the brightness of surrounding anatomy in the camera image that is not displayed as fluorescing green
BACKLIGHT DOWN	Decrease Backlight level
BACKLIGHT CYCLE	Increase Backlight level until maximum level, then cycle back to minimum level
BRIGHTNESS UP	Increase brightness level
BRIGHTNESS DOWN	Decrease brightness level
BRIGHTNESS CYCLE	Increase brightness until maximum level, then cycle back to minimum level
ENHANCE UP	Increase enhance level, which sharpens the camera image
ENHANCE DOWN	Decrease enhance level
ENHANCE CYCLE	Increase enhance until maximum level, then cycle back to minimum level
HUB FUNCTION	Signal the device control console to perform an assignable command
LIGHT SOURCE TOGGLE	Toggle the light source between activating and deactivating light output
MENU OPEN	Open the menu with device control options
NO FUNCTION	No function
PICTURE	Activate picture function on digital capture console (activate Remote 1 cable)



<b>Function Name</b>	<b>Function Description</b>
RECORD	Activate record function on digital capture console (activate Remote 2 cable)
SPY GAIN UP	Increase SPY Gain level, which uses the camera processor to adjust the fluorescing appearance of the camera image
SPY GAIN DOWN	Decrease SPY Gain level
SPY GAIN CYCLE	Increase SPY Gain until maximum level, then cycle back to minimum level
SPY IMAGE CYCLE	Cycle through the SPY modes (Overlay, Contrast, and ENV). SPY mode must be turned on for Overlay, Contrast, or ENV mode to affect the video image.
SPY TOGGLE	Toggle SPY mode on/off
WHITE BALANCE	Start White Balance test
ZOOM IN	Increase zoom level
ZOOM OUT	Decrease zoom level
ZOOM CYCLE	Increase zoom until maximum level, then cycle back to minimum level

## Advanced Features

The 1688 Video Camera has additional features that are not detailed in this manual:

- Button programming
- Video image settings
- Language settings
- Light source Run/Standby controls
- Other system settings

These advanced features require in-depth knowledge of the device and should be performed only by trained personnel. For access to advanced features, contact a Stryker representative.

# Troubleshooting

Problem	Possible Solution
<b>E-01 error code (“Video Error”)</b>	<ul style="list-style-type: none"> <li>• Turn off the console, wait 3 seconds, and turn it back on.</li> <li>• Contact Stryker if the problem persists.</li> </ul>
<b>E-02 error code (“Console Overheating” warning)</b>	<ul style="list-style-type: none"> <li>• Ensure console is in a ventilated area.</li> <li>• Turn off the console, wait 3 seconds, and turn it back on.</li> <li>• Contact Stryker if the problem persists.</li> </ul>
<b>E-03 error code (“Software Mismatch”)</b>	<ul style="list-style-type: none"> <li>• Turn off the console, wait 3 seconds, and turn it back on.</li> <li>• Return the device to Stryker for service if the problem persists.</li> </ul>
<b>E-04 error code (“Error Occurred”)</b>	<ul style="list-style-type: none"> <li>• Turn off the console, wait 3 seconds, and turn it back on.</li> <li>• Contact Stryker if the problem persists.</li> </ul>
<b>E-04 error code (“Warning Occurred”)</b>	<ul style="list-style-type: none"> <li>• Turn off the console, wait 3 seconds, and turn it back on.</li> <li>• Contact Stryker if the problem persists.</li> </ul>
<b>E-05 error code (“Unauthorized Component” warning)</b>	<ul style="list-style-type: none"> <li>• Return the camera head to Stryker for service.</li> </ul> <p><b>Warning:</b> This error indicates an unauthorized component is detected within the camera head (including its cable), which voids the warranty. The functional performance and quality of the device may be impacted.</p>
<b>Touchscreen freezes</b>	<ul style="list-style-type: none"> <li>• Turn off the console, wait 3 seconds, and turn it back on.</li> </ul>
<b>“Restart Camera Console” message (Color bar background)</b>	<ul style="list-style-type: none"> <li>• Turn off the console, wait 3 seconds, and turn it back on.</li> <li>• After sterilization, ensure the camera head has cooled down before connecting it to the console.</li> </ul>

<b>Problem</b>	<b>Possible Solution</b>
<b>“System Error” message (Light blue background)</b>	<ul style="list-style-type: none"> <li>• No video detected.</li> <li>• After sterilization, ensure the camera head has cooled down before connecting it to the console.</li> <li>• Return the system for repair.</li> </ul>
<b>No color bar</b>	<ul style="list-style-type: none"> <li>• Ensure the video-out from the console is connected to the video-in on the display monitor.</li> <li>• Ensure all video systems are powered on.</li> <li>• Ensure that the camera head is not connected to the console.</li> <li>• Turn off the console, wait 3 seconds, and turn it back on.</li> </ul>
<b>Incorrect picture color</b>	<ul style="list-style-type: none"> <li>• Perform the White Balance test. (See the Performing the White Balance Test section.)</li> <li>• Check the color settings on the display monitor.</li> </ul>
<b>White Balance quality is not good</b>	<ul style="list-style-type: none"> <li>• See the solution for Picture is too dark.</li> <li>• See the solution for Picture is too bright.</li> <li>• Perform the White Balance test with the light source connected to the scope. Use metal-halide, xenon, or LED lighting (no fluorescent lighting).</li> </ul>
<b>“White Balance Fail” message on display monitor</b>	<ul style="list-style-type: none"> <li>• Using the camera head, click the Start button on the display monitor to repeat the White Balance test. Ensure there is sufficient light and the camera head is pointing at something white.</li> <li>• Using the camera head, click the Skip button to accept the current White Balance settings.</li> </ul>
<b>Picture is too dark</b>	<ul style="list-style-type: none"> <li>• Increase the camera Brightness level.</li> <li>• Increase the light source output.</li> <li>• Check the fiberoptic light cable for excessive broken fibers.</li> </ul>
<b>Picture is too bright</b>	<ul style="list-style-type: none"> <li>• Decrease the camera Brightness level.</li> <li>• Decrease the light source output.</li> </ul>

<b>Problem</b>	<b>Possible Solution</b>
<b>Noise or snow on picture when using electrocautery probes</b>	<ul style="list-style-type: none"> <li>• Plug the electrocautery generator into a separate electrical outlet and separate the camera console power cord from the electrocautery power cord.</li> <li>• Separate the camera cable from the electrocautery cable.</li> <li>• Reposition the electrocautery grounding pad on the patient.</li> </ul>
<b>Noise or snow on picture when not using electrocautery probes</b>	<ul style="list-style-type: none"> <li>• Confirm all cable connectors are securely attached.</li> <li>• Check for and replace faulty video cables.</li> </ul>
<b>No video picture when the camera head is plugged in</b>	<ul style="list-style-type: none"> <li>• Check to ensure that all devices in the video system are plugged in and powered on.</li> <li>• Check the connector on the camera-head cable for broken pins.</li> <li>• Detach the camera head from the console and reconnect.</li> <li>• Turn off the console, wait 3 seconds, and turn it back on.</li> </ul>
<b>Image is not well centered</b>	<ul style="list-style-type: none"> <li>• Release the scope from the coupler and then reconnect it. Make sure the scope is seated correctly in the coupler.</li> </ul>
<b>Variability in color reproduction between different light sources or peripherals</b>	<ul style="list-style-type: none"> <li>• Perform the White Balance test. (See the Performing the White Balance Test section.)</li> <li>• Check the settings on video peripherals.</li> <li>• Ensure the light source has a proper infrared filter (check with manufacturer specifications).</li> </ul>
<b>Foggy picture (loss of definition and clarity)</b>	<ul style="list-style-type: none"> <li>• Refocus the coupler.</li> <li>• Disassemble the scope, coupler, and camera head, and clean and dry all windows on the components.</li> </ul>

Problem	Possible Solution
<b>Optics are dirty</b>	<ul style="list-style-type: none"> <li>• Rotate the scope. If dust particles in the picture rotate, the dust is located on the scope itself. Follow the manufacturer's instructions for cleaning the eyepiece and negative lens.</li> <li>• If particles in the picture do not move when you rotate the scope, the particles are located on the coupler or camera. Remove the scope and clean the window on the front of the coupler with a dry or alcohol-tipped cotton swab.</li> <li>• Disassemble the scope, coupler, and camera head, and clean and dry all windows on the components.</li> <li>• Ensure all components are completely dry before reassembling them, or fogging may result.</li> </ul>
<b>Blurry picture</b>	<ul style="list-style-type: none"> <li>• Ensure the coupler or C-mount scope is in focus.</li> <li>• On the Home screen, ensure the surgical specialty is not set to FLEXI-SCOPE unless you are using a flexible scope.</li> <li>• Disassemble the scope, coupler, and camera head, and clean and dry all windows on the components.</li> </ul>
<b>SIDNE device does not recognize camera head</b>	<ul style="list-style-type: none"> <li>• Contact your Stryker representative for compatibility settings.</li> </ul>
<b>SPY mode won't turn on</b>	<ul style="list-style-type: none"> <li>• Confirm the requirements in the SPY Mode Requirements section have been met.</li> </ul>
<b>Visual artifacts observed when Auto Light is on</b>	<ul style="list-style-type: none"> <li>• Turn off Auto Light from the camera, and manually reduce the brightness from the light source.</li> </ul>

**Note:** If this Troubleshooting section does not resolve the problem, call Stryker Technical Support at 1-877-478-7953 (inside the U.S.) or refer to the warranty.

# Reprocessing

The camera console is not intended to come into contact with the patient. It may be cleaned, but not sterilized. Follow the instructions below.

Camera heads 1688210105, 1688310130, 1688610122, and 1688710105 are used in the sterile field and shall be cleaned and sterilized prior to every use. Follow the instructions below.

The 1688 4K Microscope Camera Head (1688210080) must not be sterilized or immersed in water. It may be used in the sterile field only with proper sterile technique. See user manual P45082 for complete instructions.

The coupler is used in the sterile field and shall be cleaned and sterilized prior to every use. For 4K Coupler (1688-020-122) reprocessing instructions, see user manual P40880.

## Cleaning and Disinfecting the Console

Follow the warnings, cautions, and instructions below to clean and disinfect the console. The user shall provide the germicidal disposable wipes (or germicidal spray and sterile cloth).



To avoid electric shock and potentially fatal injury, disconnect the console from the AC power source before cleaning.



Observe the following cautions to avoid damaging the console:

- Do not sterilize the console.
- Do not immerse the console in any liquid.
- Do not allow liquid to drip onto the console or collect on any of its surfaces. Use extra care to prevent liquid from dripping or pooling on the bottom of the LCD screen.
- Do not spray cleaning liquid directly onto the console, power buttons, or connectors. Spray the cleaning liquid onto a cloth, and use the cloth to wipe the console. Do not saturate the cloth.
- Do not clean the console with abrasive products or corrosive cleaning solutions.

1. Clean and disinfect the console using a germicidal disposable wipe<sup>1</sup> (or equivalent combination or germicidal spray and sterile cloth) according to the manufacturer's instructions.

2. Visually inspect the external surface of the device for cleanliness, focusing on hard-to-reach areas. If visible soil remains, repeat cleaning and disinfection until all visible soil is removed.

<sup>1</sup> Cleaning and disinfection were validated using PDI® Super Sani-Cloth® Germicidal Disposable Wipes.

## Cleaning, Disinfecting, and Sterilizing the Camera Head

These reprocessing instructions are provided in accordance with ISO 17664, ISO 15883, AAMI TIR12, and AAMI TIR30. The instructions have been validated by Stryker as being capable of preparing the device for re-use. To achieve the desired result, the processor shall ensure that the following instructions are performed as written in their entirety and as appropriate in the processor's facility. This normally requires routine monitoring and validation of the facility's reprocessing procedures. Stryker recommends users observe these standards when reprocessing medical devices.

### Overview

Reprocessing the device involves manual or automated cleaning with either an enzymatic or a non-enzymatic detergent, optional disinfection, and sterilization.

- **Step 1** (required): Cleaning with Enzymatic or Non-Enzymatic Detergent
- **Step 2** (optional): Disinfection
- **Step 3** (required): Sterilization

## Warnings

- This device must be cleaned and sterilized prior to the first use and after every subsequent use.
- Separate the camera head, coupler (when used with 1688210105 and 1688710105 only), and endoscope prior to cleaning, disinfection, or sterilization. Failure to follow this instruction will render the devices non-sterile. (Refer to the coupler and endoscope product manuals for reprocessing instructions for those devices.)
- Wear appropriate protective equipment: gloves, eye protection, etc.
- To avoid health risks from aerosol contamination, brush the device only when it is submerged in liquid.
- Use only the sterilization cycles outlined in this document. Using unspecified sterilization cycles may damage the device or result in incomplete sterilization.
- The sterilization parameters presented in this document apply only when the device is sterilized outside of a sterilization tray. When using a

sterilization tray, consult the instructions provided with the tray for proper sterilization parameters. Stryker recommends sterilizing the device inside of a sterilization tray.

- Sterilize only one camera head per tray, or incomplete sterilization may result. Follow any instructions provided with the sterilization tray or system regarding tray setup and other devices that may be sterilized within the same tray.
- Devices repaired by or purchased from third-party service organizations could expose patients to significant risk. These devices are no longer validated by Stryker for cleanliness, disinfection, and sterilization, or for safety and efficacy.
- The user shall defer to the facility's procedures regarding occupational exposure to bloodborne pathogens.

## Cautions

- Always install the soaking cap prior to processing the camera. Failure to properly tighten the soaking cap will corrode the connector pins and void the warranty. Refer to the Installing the Soaking Cap section for more detail about installing the cap.
- Inspect the camera cable for cuts and breaks before soaking in any fluid. Return any damaged camera to Stryker for service.
- Never store the camera in the same tray with sharp instruments. Do not soak the camera while it is inside a tray.
- Do not use brushes or pads with metal or abrasive tips during manual cleaning, as permanent scoring or damage could result.
- To minimize galvanic corrosion, avoid soaking dissimilar metals in close proximity.
- The device cannot withstand an automated disinfection method.
- The 1688 camera heads are not autoclavable. Steam sterilizing camera heads that are not marked **AUTOCLAVE** will result in product damage.
- Allow the camera head to cool before connecting it to the console. Connecting the camera head while it is hot may result in system error.

## Limitations on Reprocessing

- Do not cross-sterilize the device. Using multiple sterilization methods may significantly reduce the performance of the device.
- Repeated automated cleaning can degrade the product's cosmetic appearance.
- Damage caused by improper processing is not covered by the warranty.



## Materials and Equipment

All materials and equipment required to reprocess the camera head shall be supplied by the user unless otherwise noted.

Item	Description
<b>All phases</b>	
Gloves, eye protection, etc.	Wear protective equipment as required by the medical facility and procedure.
<b>Cleaning</b>	
Wash basin	Large enough to accommodate camera head without excessive bending of cable
Lukewarm water	To prepare cleaning solutions
Detergent <sup>1</sup>	Used in cleaning solution to remove surgical debris
Soft-bristle brush <sup>2</sup>	To clean exterior of device or hard-to-reach areas of device
Reverse osmosis/deionized water <sup>3</sup>	To rinse device
Clean cloth or filtered pressurized air ( $\leq 40$ psi)	To assist with drying
Automated washer	For using the automated cleaning procedure
<b>Disinfection</b>	
Wash basin	Large enough to accommodate camera head without excessive bending of cable
Disinfecting solution <sup>4</sup>	$\geq 2.4\%$ glutaraldehyde
Water	To prepare disinfecting solution
Reverse osmosis/deionized water <sup>3</sup>	To rinse the device
Clean cloth or filtered pressurized air ( $\leq 40$ psi)	To assist with drying
<b>Sterilization</b>	
Sterilization system	<ul style="list-style-type: none"> <li>· Sterrad® 100S, NX®, 100NX®, NX AllClear®, or 100NX AllClear</li> <li>· Steris/Amsco® V-PRO® 1, V-PRO 1 Plus, V-PRO maX, V-PRO maX 2, or V-PRO 60</li> </ul>
Sterilization wrap <sup>5,6</sup>	To maintain sterile barrier
Sterilization tray <sup>5,7</sup>	Optional. Must be compatible with sterilization method.

<sup>1</sup> The following detergents were validated for cleaning efficacy according to the manufacturer's instructions. Choose one of the detergents listed below or a substantially equivalent detergent:

Detergent	Type	Minimum Concentration	Minimum Soak Time
ENZOL® Enzymatic Detergent	Enzymatic	1 oz/gallon	1 minute
Prolystica® 2x Neutral Detergent	Non-enzymatic	1/8 oz/gallon (1 ml/L)	5 minutes
Neodisher® MediClean Forte	Enzymatic	5/8 oz/gallon (5 ml/L)	5 minutes

<sup>2</sup> Cleaning was validated with an M16 soft-bristle brush.

<sup>3</sup> Rinsing the device during cleaning and disinfection was validated using reverse osmosis/deionized (RO/DI) water at ≤30°C.

<sup>4</sup> Disinfection was validated using CIDEX® Activated at 25 °C with a soaking time of 45 minutes.

<sup>5</sup> Sterilization was validated using Halyard Kimguard ONE-STEP sterilization wrap.

<sup>6</sup> For United States users: when sterilizing the device, use only sterilization wraps and sterilization trays that have been cleared by the FDA to use with the selected sterilization cycle.

<sup>7</sup> Stryker sterilization trays 0233-032-301, 0233-032-302, 0233-032-105, 0233-032-107, and 0233-410-002 are validated as compatible with camera heads 1688210105, 1688610122, and 1688710105. The same sterilization trays except for 0233-032-107 are validated as compatible with camera head 1688310130.

## Instructions for Reprocessing

### Point of Use

- Disassemble the camera head from the coupler (1688210105 and 1688710105 only) and from the endoscope. To disconnect the coupler, grip the rear adapter of the coupler and unscrew it counterclockwise from the camera head. To disconnect the endoscope, depress the endobody clamp on the coupler—or for 1688310130, twist the clamp clockwise when the buttons are facing you—and remove the endoscope from the coupler.
- Wipe any excess soil from the device.

### Containment and Transportation

- Reprocess the device as soon as possible following use.
- Transport the device in a tray to avoid damage. Follow the facility's internal procedures for the transportation of contaminated surgical instruments and devices.

### Cleaning

- 1 Follow the Preparation for Cleaning instructions below.
- 2 Then clean the device using either the Manual Cleaning or Automated Cleaning instructions below.

**Note:** For necessary materials and equipment, see the Materials and Equipment table.

### Preparation for Cleaning

1. Fill a wash basin with lukewarm water.
2. Measure and dispense the desired amount of detergent into the water.

**Note:** See the Materials and Equipment table for validated detergents with their minimum concentration.

3. Gently mix the detergent into the water by hand.
4. Submerge the device into the prepared wash basin.
5. With the device immersed in the solution, thoroughly brush the exterior with a soft-bristled brush, focusing on any mated or rough surfaces.
6. Actuate and brush any movable parts in all extreme positions.
7. Rinse each device with water until all detergent residue is removed.
8. Once all detergent residue is removed, continue to rinse for 30 seconds.
9. Drain excess water from the device and dry it using a clean cloth or pressurized air.
10. Visually inspect each device for cleanliness, paying close attention to hard-to-reach areas. If visible soil remains, repeat steps 1– 10.

### Manual Cleaning

1. Prepare a fresh solution of detergent with lukewarm water.  
**Note:** See the Materials and Equipment table for validated detergents with their minimum concentration and soak time.
2. Wipe the entire surface of the device using a soft clean cloth dipped in the detergent solution.
3. Immerse the device in the detergent solution, ensuring the solution contacts all inner and outer surfaces.
4. Soak the device in the solution according to the manufacturer's recommendations.
5. With the device immersed in the solution, thoroughly brush the exterior with a soft-bristle brush, focusing on any mated or rough surfaces.
6. Actuate and brush any movable parts in all extreme positions.
7. Rinse each device with water until all detergent residue is removed.
8. Once all detergent residue is removed, continue to rinse for 30 seconds.
9. Drain excess water from the device and dry it using a clean cloth or pressurized air.
10. Visually inspect each device for cleanliness, paying close attention to hard-to-reach areas. If visible soil remains, repeat steps 1– 10.

### Automated Cleaning



The device cannot withstand an automated disinfection method. When programming the washer, do not include a thermal rinse cycle or the device will be damaged.

1. Place the device in the automated washer on an incline to facilitate drainage.
2. Program the washer using the following parameters:

Phase	Recirculation Time	Temperature	Detergent Type
Pre-Wash	2 minutes	Cold Water	N/A
Wash 1	5 minutes	Set Point 60 °C (140 °F)	See Materials and Equipment table
Rinse 1	2 minutes	Hot Water	N/A
Dry Phase	2 minutes	115 °C (239 °F)	N/A

3. Drain excess water from the device and dry it using a clean cloth or pressurized air.
4. Visually inspect each device for cleanliness, paying close attention to hard-to-reach areas. If visible soil remains, repeat steps 1– 4.

### High-Level Disinfection (Optional)



The device must be sterilized after disinfection. Failure to sterilize the device before reuse presents an acute infection control risk to the patient.

**Note:** For necessary materials and equipment, see the Materials and Equipment table.

The device can be disinfected using a disinfecting solution that has the following active ingredient:  $\geq 2.4\%$  glutaraldehyde.

1. Clean and prepare the device as recommended in this user manual. Ensure the soaking cap is installed.
2. Prepare the disinfecting solution and verify the minimum effective concentration according to the manufacturer instructions.
3. Immerse the device in the solution, filling all mated surfaces and crevices. Ensure air bubbles are removed from the surface of the device.
4. Allow the device to remain in contact with the disinfecting solution according to the manufacturer's recommended soak time.
5. Thoroughly rinse and flush the device with running, reverse osmosis/ deionized water to remove the disinfectant.
6. Dry the device with a sterile, lint-free cloth immediately after rinsing. Filtered pressurized air may be used to assist in drying.

## Sterilization

After performing the cleaning instructions specified above, perform one of the following sterilization cycles. **Note:** For necessary materials and equipment, see the Materials and Equipment table.

### Sterrad

1. Clean and prepare the device as recommended in this user manual. Ensure the soaking cap is installed.
2. If using a sterilization tray (optional), follow any additional instructions provided with the tray. Use only trays that are compatible with Sterrad.
3. Double wrap the device (or tray) prior to sterilization.
4. Sterilize the device using one of the following Sterrad sterilization systems:
  - 100S (Short or Long<sup>1</sup> cycle)
  - NX (Standard or Advanced cycle)
  - 100NX (Standard or DUO cycle)
  - NX AllClear (Standard or Advanced cycle)
  - 100NX AllClear (Standard or DUO cycle)
5. Allow the device to cool to room temperature before reconnecting it to the camera system. Otherwise, the lens can fog during use or the console can produce a system error.

<sup>1</sup> Sterrad 100S Long cycle is intended for use outside the U.S. only.

### Steris/Amsco V-PRO

1. Clean and prepare the device as recommended in this user manual. Ensure the soaking cap is installed.
2. If using a sterilization tray (optional), follow any additional instructions provided with the tray. Use only trays that are approved for sterilization with V-PRO.
3. Double wrap the device (or tray) prior to sterilization.
4. Sterilize the device using one of the following V-PRO sterilization systems:
  - V-PRO 1 (Standard cycle)
  - V-PRO 1 Plus (Non-Lumen or Lumen cycle)
  - V-PRO 60 (Non-Lumen, Lumen, or Flexible cycle)
  - V-PRO maX (Non-Lumen, Lumen, or Flexible cycle)
  - V-PRO maX 2 (Non-Lumen, Lumen, Flexible, or Fast Non-Lumen<sup>1</sup> cycle)
5. Allow the device to cool to room temperature before reconnecting it to the camera system. Otherwise, the lens can fog during use or the console can produce a system error.

<sup>1</sup> **Warning:** When using the Fast Non-Lumen cycle, follow the instructions provided with the V-PRO maX 2 system regarding use of rigid containers or sterilization wrap. The cycle is intended to be used with sterilization pouches. Also observe the Fast Non-Lumen cycle weight limit of up to 11 pounds (4.99 kg) of instruments.

# Maintenance

Follow the instructions in this section for proper care of the device.

**Note:** Repairs and equipment modifications shall be performed only by Stryker-authorized personnel. Stryker Endoscopy assumes no product liability or warranty responsibility for devices repaired by or purchased from third-party service organizations.

## Inspecting the Console

Inspect the console regularly for cleanliness. If the console appears dirty, repeat the above cleaning and disinfection procedure.

Regularly inspect the lock ring on the front of the console (located at the camera connection port). Confirm the lock ring is not loose; tighten if necessary by manually turning the lock ring clockwise.

Inspect the console before each use. If a problem listed below is observed or suspected, contact your Stryker representative or return the device to Stryker for service.

- If the console is unresponsive to touchscreen button presses or cannot power on
- Visible cuts or breaks in any cables
- Unacceptable deterioration such as (but not limited to) corrosion, discoloration, pitting, cracked seals, or abnormal noises

## Inspecting the Camera Head

Inspect all components of the camera head for cleanliness before each use. If fluid or tissue buildup is present, repeat the above cleaning and sterilization procedures.

Inspect the camera head before each use. If a problem listed below is observed or suspected, contact your Stryker representative or return the device to Stryker for service

- If the image output performance of the camera is unacceptable. (For camera heads 1688210105 and 1688710105, use a coupler that has been inspected per the coupler user guide.) The camera head shall be able to provide an image that is clear and focusable with adequate response to lighting of various scenes.
- If the console is unresponsive to pressing camera head buttons
- Visible cuts or breaks in the camera head cable or keypad area
- Unacceptable deterioration such as corrosion, pitting, cracked seals, or abnormal noises

## Using Sterile Drapes

Using sterile drapes will ensure maximum longevity of the camera. For best results, follow the instructions provided by the drape manufacturer.

## Storage

Store the device in a dry, clean, and dust-free environment at room temperatures.

## Replacing the Fuses



To avoid the risk of fire, use only fuses of the value specified on the fuse label located on the rear panel of the device.

1. Unplug the power cord from the wall outlet and remove the cord from the device.
2. Unlatch the fuse holder above the AC inlet and remove it. (You may need to press the tab on the fuse holder with a slender screwdriver to release the latch.)
3. Replace the fuse with the same value and rating.
4. Reinstall the fuse holder until the tab snaps in place.

## Periodic Maintenance Schedule



To ensure safe operation of the device, you should periodically perform the following procedure:

Every 12 months, check the earth leakage current to  $<500 \mu\text{A}$  ( $<300 \mu\text{A}$  in USA), ground protective earth impedance to  $<0.1$  ohms, and power consumption less than or equal to rated power. Use a true RMS digital multimeter and safety analyzer to perform this test.

**Note:** Refer calibration and operating difficulties not detailed in this manual to your Stryker representative.

## Service Life

The 1688 camera console has an expected service life of 4 years.

The 1688 camera heads have an expected service life of 2 years.

Expected service life is determined by the number of times the device can be expected to be reused and/or reprocessed before it may require repair. In addition, the device's service life is largely determined by wear, reprocessing methods, and any damage resulting from use. To extend the time between device servicing, always follow the care and handling instructions in this user manual.

Before each use, test the device functionality and inspect it for any sign of damage per the Inspection section. If the device does not properly function or appears to be damaged, return it to Stryker for evaluation and/or repair. Repair through Stryker, the equipment manufacturer, brings the device back to manufacturer specifications. Clean and (when applicable) sterilize all potentially contaminated devices before returning them to Stryker.

## Disposal



This product contains electrical waste or electronic equipment. It must not be disposed of as unsorted municipal waste and must be collected separately in accordance with applicable national or institutional related policies relating to obsolete electronic equipment.

Dispose of the product according to local laws and hospital practices. Refer to the recycling diagram(s) to identify components that must be recycled.



# Recycling Diagrams

## Console

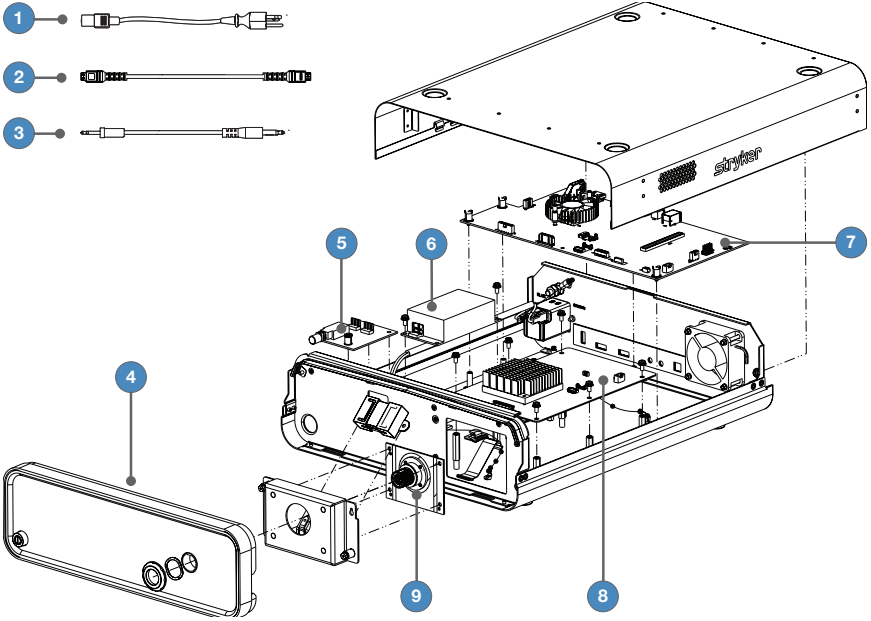

Item	Material	Qty.	Comments
1	AC Power Cord	1	Cable length abbreviated in diagram
2	HDMI Cable	1	Cable length abbreviated in diagram
3	Remote Cable	2	Cable length abbreviated in diagram
4	PC Board	2	Behind front panel (not shown in diagram)
5	PC Board	1	—
6	Power Supply	1	—
7	PC Board	1	—
8	PC Board	1	—
9	PC Board	1	—

## Camera Head

Camera head model 1688210105 is shown below to represent features that are common to each camera head.

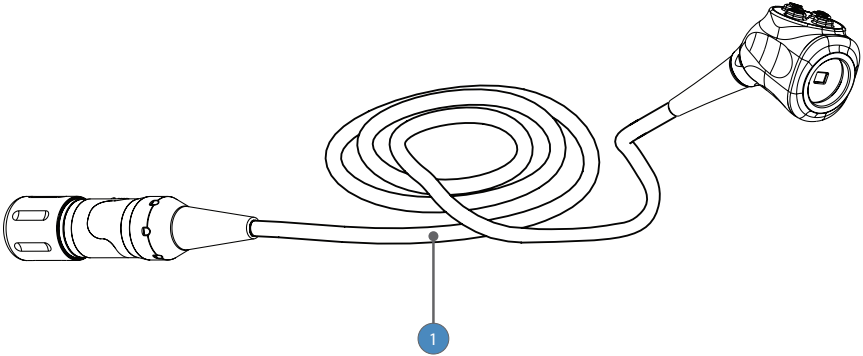

Item	Material	Qty.	Comments
1	Cable	1	—

Note: In accordance with the European REACH Regulation and other environmental regulatory requirements, lead metal is present in a concentration above 0.1% weight by weight (w/w) in some components of the cable assembly for the 1688 Camera Heads. This declaration is made in good faith and is based upon supplier data.

# Technical Specifications

<b>Imaging System</b>	1/2.8" Progressive Scan CMOS Ultra High Definition
<b>Scanning System</b>	Horizontal: 135.00 kHz Vertical: 60.00 Hz
<b>Video Outputs</b>	Two HDMI 2.0 outputs Formats: 1080p (HDTV), 4K UHD (3840 x 2160)
<b>Mounting</b>	Endoscope eyepiece used with C-mount coupler C-mount camera head used with C-mount scopes (C-mount coupler/scope thread: 1-32" UN 2A)
<b>Auto Shutter Range</b>	1/60 – 1/22,478 second
<b>Operating Conditions</b>	Temperature: 10–30 °C Relative Humidity: 25–75% Atmospheric pressure: 700–1060 hPA
<b>Transport and Storage Conditions</b>	Temperature: -18–60 °C Relative Humidity: 15–90%
<b>Input Electrical Ratings</b>	100–240V~ 50/60Hz 1.2A
<b>Device Weight</b>	12.0 lb (5.44 kg) Camera Console 1.0 lb (0.5 kg) Camera Head (approximate weight)
<b>Dimensions</b>	Camera Console: 13.0" w × 4.458" h × 16.627" d (33.02 cm w × 11.32 cm h × 42.23 cm d) Camera Head Cable: 10 ft (3.05 m) sealed cable
<b>Classification</b>	Class I Medical Electrical Equipment Continuous Operation Type BF Applied Part Ingress Protection, IPX7—Protected against the effects of temporary immersion in water (1688210105, 1688310130, 1688610122, and 1688710105)

## Electromagnetic Compatibility

All electrical medical equipment requires special precautions to ensure electromagnetic compatibility with other electrical medical devices. To ensure electromagnetic compatibility (EMC), the device must be installed and operated according to the EMC information provided in this manual.

### Note:

- The device has been designed and tested to comply with IEC 60601-1-2 requirements for EMC with other devices.
- This equipment is for use in a professional healthcare environment. It is not for use in the radio frequency (RF) shielded room of a medical electrical system for magnetic resonance imaging, where the intensity of electromagnetic disturbances is high.
- The device is not likely susceptible to interference from high-frequency (HF) surgical instruments in the Special Environment of being in close proximity to an active HF surgical instrument. In the case that HF surgical interference is observed, adjust the separation distance of the equipment.



- Do not use cables or accessories other than those provided with the device, as this may result in increased electromagnetic emissions or decreased immunity to such emissions.
- If the device is used adjacent to or stacked with other equipment, observe and verify normal operation of the device in the configuration which it will be used prior to a surgical procedure.
- Equipment which employs radio frequency (RF) communications may affect the normal function of the device.

### Guidance and Manufacturer's Declaration: Electromagnetic Emissions

The device is intended for use in the electromagnetic environment specified below. The customer or user of the device should ensure that it is used in such an environment.

Emissions test	Compliance	Electromagnetic Environment - guidance
RF emissions CISPR 11	Class B	The device is suitable for use in all establishments other than domestic establishments and those directly connected to the public low-voltage power supply network that supplies buildings used for domestic purposes, provided the following warning is heeded:  <b>Warning:</b> This system is intended for use by health care professionals only. This system may cause radio interference or may disrupt the operation of nearby equipment. It may be necessary to take mitigation measures, such as reorienting or relocating the system or shielding the location.
Harmonic emissions IEC61000-3-2	Class A	
Voltage Fluctuations/ flicker emissions IEC61000-3-3	Complies	

Guidance and Manufacturer's Declaration: Electromagnetic Emissions		
RF emissions CISPR 11	Group 1	The device uses RF energy only for its internal function; therefore, its RF emissions are very low and are not likely to cause any interference in nearby electronic equipment.

Guidance and Manufacturer's Declaration: Electromagnetic Immunity			
The device is intended for use in the electromagnetic environment specified below. The customer or user of the device should ensure that it is used in such an environment.			
Immunity Test	IEC 60601 Test Level	Compliance Level	Electromagnetic Environment: Guidance
Electrostatic Discharge (ESD) IEC61000-4-2	±8kV contact ±15kV air	±8kV contact ±15kV air	Floors should be wood, concrete, or ceramic tile. If floors are covered with synthetic material, the relative humidity should be at least 30%.
Electrical fast transient/burst IEC61000-4-4	±2kV for power supply lines ±1kV for input/output lines (if applicable)	±2kV line to ground ±1kV for input/output lines (if applicable)	Mains power quality should be that of a typical commercial or hospital environment.
Surge IEC61000-4-5	±1kV differential mode ±2kV common mode	±1kV differential mode ±2kV common mode	Mains power quality should be that of a typical commercial or hospital environment.
Voltage dips, short interruptions and voltage variations on power supply input lines IEC61000-4-11	0% Ut; 0.5 cycle 0% Ut; 1 cycle 70% Ut; 25 cycles 0% Ut; 5 seconds		Mains power quality should be that of a typical commercial or hospital environment. If the user of the device requires continued operation during power mains interruptions, it is recommended that the device be powered from an uninterruptible power supply or a battery.
Power frequency (50/60Hz) magnetic field IEC 61000-4-8	30 A/m	30 A/m	Power-frequency magnetic fields should be at levels characteristic of a typical location in a typical commercial or hospital environment.
NOTE: Ut is the AC mains voltage prior to application of the test level.			

<b>Guidance and Manufacturer's Declaration: Electromagnetic Immunity</b>			
The device is intended for use in the electromagnetic environment specified below. The customer or user of the device should ensure that it is used in such an environment.			
<b>Immunity Test</b>	<b>IEC 60601 Test Level</b>	<b>Compliance Level</b>	<b>Electromagnetic Environment: Guidance</b>
Conducted RF IEC 61000-4-6	6 Vrms 150 kHz to 80 MHz	6 Vrms	Portable and mobile RF communications equipment should be used no closer to any part of the device, including its cables, than the recommended separation distance calculated from the equation applicable to the frequency of the transmitter.  <b>Recommended Separation Distance</b>  $d = 2\sqrt{P}$ 80 MHz to 2.7 GHz  where P is the maximum output power rating of the transmitter in watts (W) according to the transmitter manufacturer and d is the recommended separation distance in meters (m).  Field strengths from fixed RF transmitters, as determined by an electromagnetic site survey <sup>(a)</sup> , should be less than the compliance level in each frequency range <sup>(b)</sup> . Interference may occur in the vicinity of equipment marked with the following:  
Radiated RF IEC 61000-4-3	3 V/m 80MHz to 2.7 GHz	3 V/m	

<b>Guidance and Manufacturer's Declaration: Electromagnetic Immunity</b>
The device is intended for use in the electromagnetic environment specified below. The customer or user of the device should ensure that it is used in such an environment.
(a) Field strengths from fixed transmitters, such as base stations for radio (cellular/cordless) telephones and land mobile radios, amateur radio, AM and FM radio broadcast, and TV broadcast, cannot be predicted theoretically with accuracy. To assess the electromagnetic environment due to fixed RF transmitters, an electromagnetic site survey should be considered. If the measured field strength in the location in which the device is used exceeds the applicable RF compliance level above, the device should be observed to verify normal operation. If abnormal performance is observed, additional measures may be necessary, such as reorienting or relocating the device.
(b) Over the frequency range 150 kHz to 80 MHz, field strengths should be less than 3 V/m.

Tested Specifications for Immunity to RF Wireless Communications Equipment						
Test frequency (MHz)	Band (MHz)	Service	Modulation	Maximum Power (W)	Distance (m)	Immunity Test Level (V/m)
385	380–390	TETRA 400	Pulse modulation 18 Hz	1.8	0.3	27
450	430–470	GMRS 460, FRS 460	FM ± 5 kHz deviation 1 kHz sine	2.0	0.3	28
710	704–787	LTE Band 13, 17	Pulse modulation 217 Hz	0.2	0.3	9
745						
780						
810	800–960	GSM 800/900, TETRA 800, iDEN 820, CDMA 850, LTE Band 5	Pulse modulation 18 Hz	2.0	0.3	28
870						
930						
1720	1700–1990	GSM 1800; CDMA 1900; GSM 1900; DECT; LTE Band 1, 3, 4, 25; UMTS	Pulse modulation 217 Hz	2.0	0.3	28
1845						
1970						
2450	2400–2570	Bluetooth, WLAN, 802.11 b/g/n, RFID 2450, LTE Band 7	Pulse modulation 217 Hz	2.0	0.3	28
5240	5100–5800	WLAN 802.11 a/n	Pulse modulation 217 Hz	0.2	0.3	9
5500						
5785						

**Note:** Portable RF communications equipment (including peripherals such as antenna cables and external antennas) should be used no closer than 30 cm (12 inches) to any part of this device, including cables specified by the manufacturer, otherwise the device performance could degrade.

# Symbol Definitions

This device and its labeling contain symbols that provide important information for the safe and proper use of the device. These symbols are defined below.

## Touchscreen Interface/Display Monitor



WB button (turn on White Balance test)



Camera button (capture photo)



Record button (start/stop video recording)



Home button (navigate to Home screen)



AIM button (navigate to SPY screen)



Settings button (navigate to Camera Settings screen)



Auto Light button (blue=feature is on; black=feature is off)



Flexi-Scope surgical specialty is selected



Overlay SPY mode is active (icon colors are red, green, and blue)



Contrast SPY mode is active (icon colors are all grey)



ENV SPY mode is active (icon colors are all green)

## Device/Package Labeling



Consult instructions for use



















Caution (consult instructions for use)



Consult instruction manual



	Federal law (USA) restricts this device to use by, or on order of, a physician
	Device is shipped non-sterile and must be sterilized before use
	Date of manufacture
	Legal manufacturer
	Product catalog number
	Product serial number
	Quantity
	Made in USA
	The device meets European Union medical device requirements.
	Stryker European representative
	Denotes compliance to CAN/CSA C22.2 No 60601-1 and ANSI/AAMI 60601-1
	Type BF applied part
	1688 Camera Head connection
	Power on/off (alternates when button is pushed)
	Equipotentiality
	Alternating current
	Fuse rating



Device recycling code (applicable in China)



This product contains electrical waste or electronic equipment. It must not be disposed of as unsorted municipal waste and must be collected separately.

## User Manual



Radiation emitting



**stryker**<sup>®</sup>



Stryker Endoscopy  
5900 Optical Court  
San Jose, CA 95138 USA  
1-800-624-4422

U.S. Patents: [www.stryker.com/patents](http://www.stryker.com/patents)

Stryker or its divisions or other corporate affiliated entities own, use or have applied for the following trademarks or service marks: SafeLight and the Stryker logo. All other trademarks are trademarks of their respective owners or holders.

P38139G  
2020/02  
WCR: NONE