



Monopolar
electrodes

Legend

Important notes

The authors and Erbe Elektromedizin GmbH have taken the greatest possible care while compiling the catalogue with electrosurgical accessories. Nevertheless, it is impossible to exclude the possibility that errors may be contained herein.

The information and recommendations given here may not be construed as constituting any basis for any claims against Erbe Elektromedizin GmbH. Should legal regulations stipulate liability, such liability shall be limited to intentional misconduct or gross negligence.

The data on the use of instruments is based on clinical experience. Medical science is subject to a process of permanent change based on research and clinical experience. Therefore the products are subject to alterations in design and technique. Because of production tolerances dimensions in the catalogue may marginally differ.

We confirm that none of our products contain latex, except the rubber straps, Art. No. 20592-009 and 20592-011.

Further product information

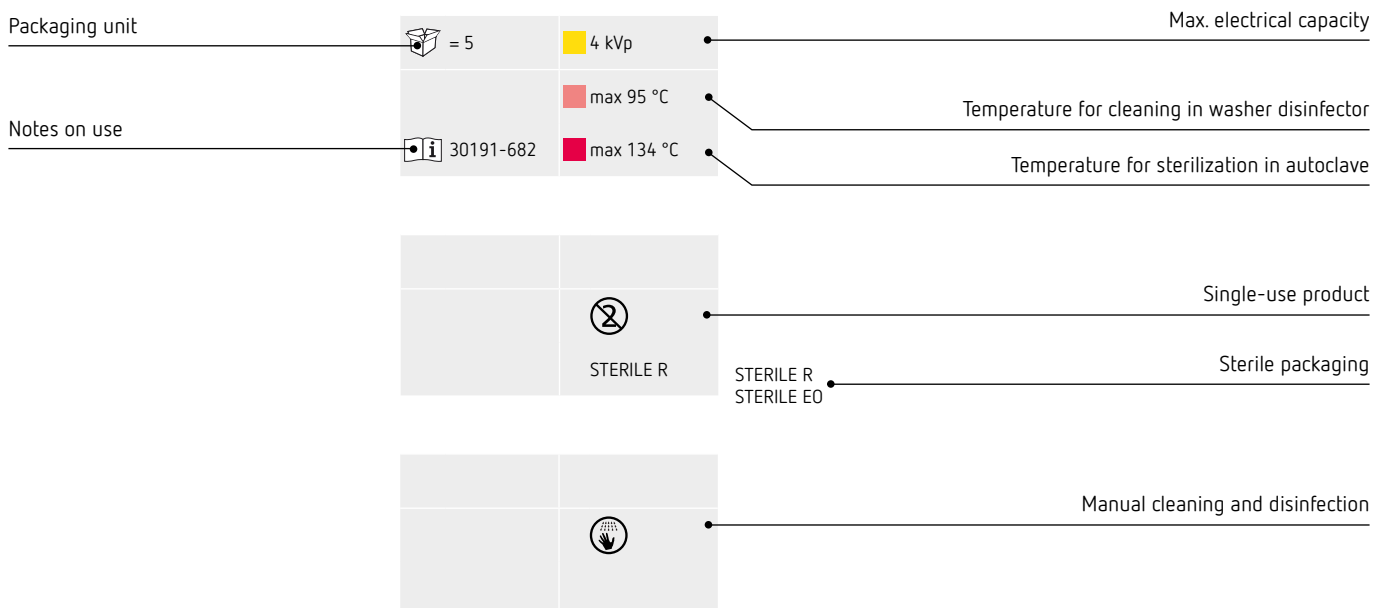

Please read carefully the corresponding notes on use before using any instrument.

Electrosurgery

Monopolar electrodes

- 05 Reusable, shaft \varnothing 2.4 mm and shaft \varnothing 4 mm
- 22 Single use, shaft \varnothing 2.4 mm
- 28 Single use, shaft \varnothing 2 mm for arthroscopy
- 29 Shaft extensions, chucks, cleaning pad

Monopolar instruments

- 30 Instruments for MIS

Overview

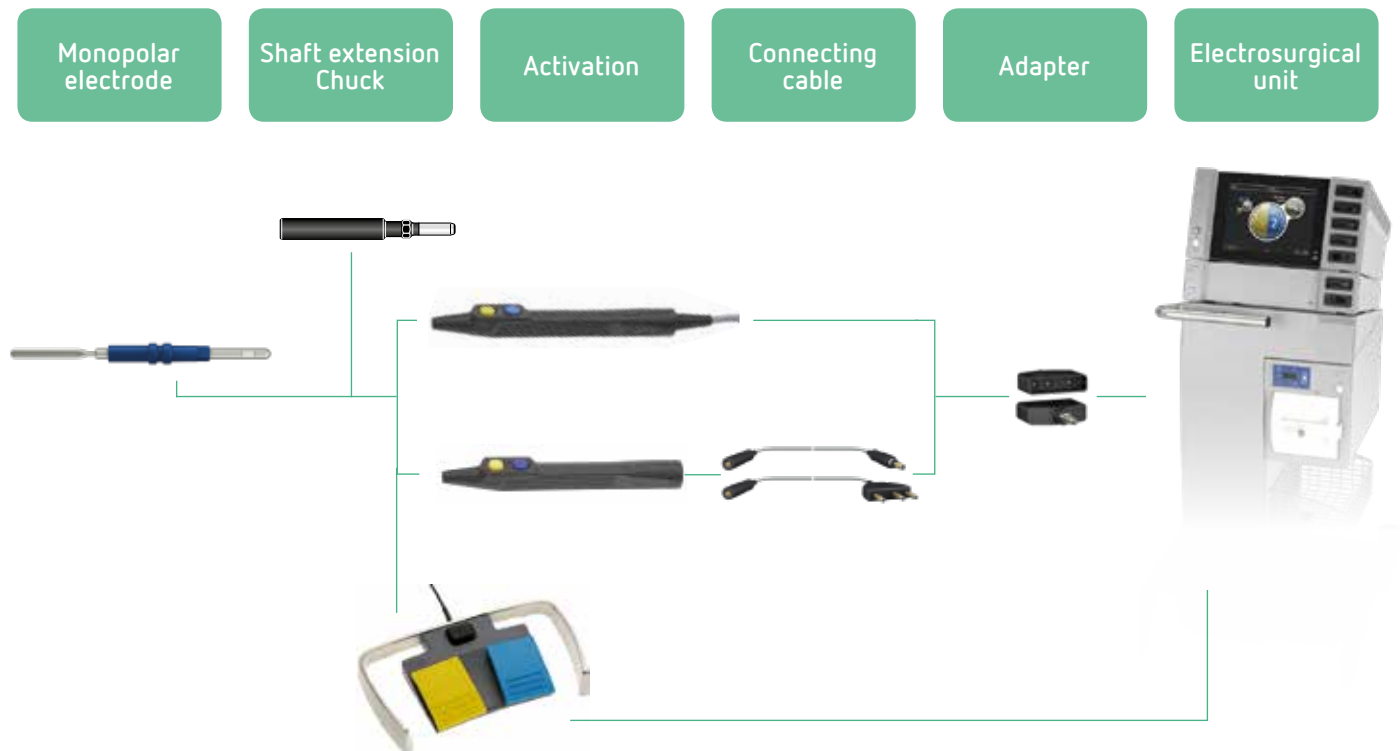

Monopolar electrodes

Dimensioning

Spatula electrode, straight, 2.3 x 19 mm, length 120 mm



Ball electrode, straight, \varnothing 4 mm, length 110 mm



Needle electrode, straight, \varnothing 0.8 x 15 mm, length 120 mm



Tungsten snare electrode, straight, \varnothing 20 mm, length 140 mm

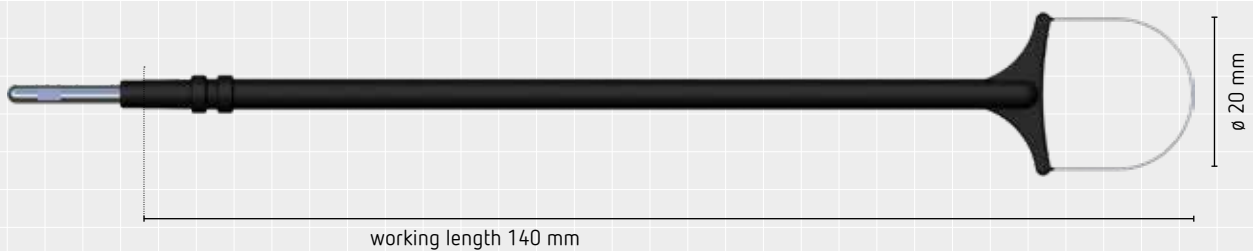

Monopolar electrodes

Reusable, shaft \varnothing 2.4 mm and shaft \varnothing 4 mm

Knife electrode, straight, 3.4 x 18 mm, length 40 mm



No. 21191-172

No. 21191-072



4.3 kVp

max 95 °C



31191-211

max 138 °C

Knife electrode, straight, 1.5 x 17 mm, length 40 mm



No. 21191-101

No. 21191-001



4.3 kVp

max 95 °C



31191-211

max 138 °C

Knife electrode, straight, 3.4 x 24 mm, length 45 mm



No. 21191-100

No. 21191-000



4.3 kVp

max 95 °C



31191-211

max 138 °C

Spatula electrode, straight, 3 x 24 mm, length 45 mm



No. 21191-102

No. 21191-002



4.3 kVp

max 95 °C



31191-211

max 138 °C

Spatula electrode, straight, 2.3 x 19 mm, length 45 mm



No. 21191-159

No. 21191-059



4.3 kVp

max 95 °C



31191-211

max 138 °C

Spatula electrode, straight, insulated, 2.3 x 19 mm, length 45 mm



No. 21191-161

No. 21191-061



4.3 kVp

max 95 °C



31191-211

max 138 °C

No. \varnothing 2.4 mm shaft

No. \varnothing 4 mm shaft

Monopolar electrodes

Reusable, shaft \varnothing 2.4 mm and shaft \varnothing 4 mm

Spatula electrode, straight, flexible, 2 x 6 mm, length 45 mm

e.g. for coronary bypass surgery



No. 21191-107

No. 21191-007



= 5

4.3 kVp

max 95 °C



31191-211

max 138 °C

Spatula electrode, straight, flexible, 2 x 18 mm, length 45 mm

e.g. for coronary bypass surgery



No. 21191-106

No. 21191-006



= 5

4.3 kVp

max 95 °C



31191-211

max 138 °C

Spatula electrode, straight, flexible, 1.7 x 6 mm, length 50 mm

e.g. for coronary bypass surgery



No. 21191-105

No. 21191-005



= 5

4.3 kVp

max 95 °C



31191-211

max 138 °C

Spatula electrode, straight, flexible, 3 x 24 mm, length 60 mm

e.g. for coronary bypass surgery



No. 21191-103

No. 21191-003



= 5

4.3 kVp

max 95 °C



31191-211

max 138 °C

Spatula electrode, straight, flexible, 2 x 18 mm, length 80 mm

e.g. for coronary bypass surgery



No. 21191-104

No. 21191-004



= 5

4.3 kVp

max 95 °C



31191-211

max 138 °C

Spatula electrode, straight, 2.3 x 19 mm, length 120 mm



No. 21191-153

No. 21191-053



= 1

4.3 kVp

max 95 °C



31191-211

max 138 °C

No. \varnothing 2.4 mm shaft

No. \varnothing 4 mm shaft

Monopolar electrodes

Reusable, shaft \varnothing 2.4 mm and shaft \varnothing 4 mm

Spatula electrode, straight, insulated, 2.3 x 19 mm, length 120 mm



No. 21191-155

No. 21191-055



= 1

4.3 kVp

max 95 °C



31191-211

max 138 °C

Knife electrode, straight, 2.4 x 12 mm, length 120 mm



No. 21191-110

No. 21191-010



= 1

4.3 kVp

max 95 °C



31191-211

max 138 °C

Spatula electrode, straight, 2.4 x 12 mm, length 120 mm



No. 21191-156

No. 21191-056



= 1

4.3 kVp

max 95 °C



31191-211

max 138 °C

Spatula electrode, straight, 2.3 x 19 mm, length 180 mm



No. 21191-157

No. 21191-057



= 1

4.3 kVp

max 95 °C



31191-211

max 138 °C

Spatula electrode, straight, insulated, 2.3 x 19 mm, length 180 mm



No. 21191-158

No. 21191-058



= 1

4.3 kVp

max 95 °C



31191-211

max 138 °C

No. \varnothing 2.4 mm shaft

No. \varnothing 4 mm shaft

Monopolar electrodes

Reusable, shaft \varnothing 2.4 mm and shaft \varnothing 4 mm

Knife electrode, bent, 1.5 x 17 mm, length 30 mm



No. 21191-108

No. 21191-008



4.3 kVp

max 95 °C



31191-211

max 138 °C

Spatula electrode, bent, 2.3 x 19 mm, length 40 mm



No. 21191-160

No. 21191-060



4.3 kVp

max 95 °C



31191-211

max 138 °C

Spatula electrode, bent, insulated, 2.3 x 19 mm, length 40 mm



No. 21191-162

No. 21191-062



4.3 kVp

max 95 °C



31191-211

max 138 °C

Spatula electrode, bent, 3 x 24 mm, length 40 mm



No. 21191-109

No. 21191-009



4.3 kVp

max 95 °C



31191-211

max 138 °C

Spatula electrode, bent, 2.3 x 19 mm, length 115 mm



No. 21191-154

No. 21191-054



4.3 kVp

max 95 °C



31191-211

max 138 °C

Knife electrode, bent, 2.4 x 12 mm, length 115 mm



No. 21191-111

No. 21191-011



4.3 kVp

max 95 °C



31191-211

max 138 °C

No. \varnothing 2.4 mm shaft

No. \varnothing 4 mm shaft

Monopolar electrodes

Reusable, shaft \varnothing 2.4 mm and shaft \varnothing 4 mm

Needle electrode, straight, \varnothing 0.8 x 17 mm, length 35 mm



No. 21191-171

No. 21191-071



= 5

4.3 kVp

max 95 °C



31191-211

max 138 °C

Needle electrode, straight, \varnothing 0.8 x 22 mm, length 40 mm



No. 21191-112

No. 21191-012



= 5

4.3 kVp

max 95 °C



31191-211

max 138 °C

Needle electrode, straight, insulated, \varnothing 0.8 x 22 mm, length 40 mm



No. 21191-168

No. 21191-068



= 5

4.3 kVp

max 95 °C



31191-211

max 138 °C

Needle electrode, straight, \varnothing 0.8 x 29 mm, length 65 mm



No. 21191-113

No. 21191-013



= 1

4.3 kVp

max 95 °C



31191-211

max 138 °C

Needle electrode, straight, insulated, \varnothing 0.8 x 15 mm, length 115 mm



No. 21191-169

No. 21191-069



= 1

4.3 kVp

max 95 °C



31191-211

max 138 °C

Needle electrode, straight, \varnothing 0.8 x 15 mm, length 120 mm



No. 21191-120

No. 21191-020



= 1

4.3 kVp

max 95 °C



31191-211

max 138 °C

No. \varnothing 2.4 mm shaft

No. \varnothing 4 mm shaft

Monopolar electrodes

Reusable, shaft \varnothing 2.4 mm and shaft \varnothing 4 mm

Needle electrode, straight, \varnothing 0.8 x 15 mm, length 180 mm



No. 21191-170

No. 21191-070



4.3 kVp

max 95 °C



31191-211

max 138 °C

Needle electrode, bent, \varnothing 0.8 x 20 mm, length 35 mm



No. 21191-115

No. 21191-015



4.3 kVp

max 95 °C



31191-211

max 138 °C

Needle electrode, bent, \varnothing 0.8 x 12 mm, length 45 mm



No. 21191-151

No. 21191-051



4.3 kVp

max 95 °C



31191-211

max 138 °C

Needle electrode, bent, \varnothing 0.8 x 10 mm, length 120 mm



No. 21191-121

No. 21191-021



4.3 kVp

max 95 °C



31191-211

max 138 °C

Tungsten needle electrode, straight, insulated, \varnothing 0.5 x 3 mm, length 40 mm

e.g. for precise skin incisions



No. 21191-116

No. 21191-016



1 kVp

max 95 °C



31191-211

max 138 °C

Tungsten needle electrode, straight, insulated, \varnothing 0.5 x 3 mm, length 55 mm

e.g. for precise skin incisions



No. 21191-118

No. 21191-018



1 kVp

max 95 °C



31191-211

max 138 °C

No. \varnothing 2.4 mm shaft

No. \varnothing 4 mm shaft

Monopolar electrodes

Reusable, shaft \varnothing 2.4 mm and shaft \varnothing 4 mm

Tungsten needle electrode, bent, insulated, \varnothing 0.5 x 3 mm, length 35 mm

e.g. for precise skin incisions



No. 21191-117

No. 21191-017



1 kVp

max 95 °C



31191-211

max 138 °C

Tungsten needle electrode, bent, insulated, \varnothing 0.5 x 3 mm, length 55 mm

e.g. for precise skin incisions



No. 21191-119

No. 21191-019



1 kVp

max 95 °C



31191-211

max 138 °C

Coagulation electrode, straight, insulated, \varnothing 1 mm, length 120 mm

e.g. for incision of the concha nasalis, for body cavities



No. 21191-114

No. 21191-014



1 kVp

max 95 °C



31191-211

max 138 °C

Coagulation electrode, bent, insulated, \varnothing 1 mm, length 115 mm

e.g. for incision of the concha nasalis, for body cavities



No. 21191-122

No. 21191-022



1 kVp

max 95 °C



31191-211

max 138 °C

No. \varnothing 2.4 mm shaft

No. \varnothing 4 mm shaft

Monopolar electrodes

Reusable, shaft \varnothing 2.4 mm and shaft \varnothing 4 mm

Ball electrode, straight, \varnothing 2 mm, length 40 mm



No. 21191-123

No. 21191-023



= 5

4.3 kVp

max 95 °C



31191-211

max 138 °C

Ball electrode, straight, \varnothing 3 mm, length 40 mm



No. 21191-163

No. 21191-063



= 5

4.3 kVp

max 95 °C



31191-211

max 138 °C

Ball electrode, straight, \varnothing 4 mm, length 40 mm



No. 21191-124

No. 21191-024



= 5

4.3 kVp

max 95 °C



31191-211

max 138 °C

Ball electrode, straight, \varnothing 5 mm, length 40 mm



No. 21191-164

No. 21191-064



= 5

4.3 kVp

max 95 °C



31191-211

max 138 °C

Ball electrode, straight, \varnothing 6 mm, length 40 mm



No. 21191-125

No. 21191-025



= 5

4.3 kVp

max 95 °C



31191-211

max 138 °C

Ball electrode, straight, \varnothing 3 mm, length 110 mm



No. 21191-165

No. 21191-065



= 1

4.3 kVp

max 95 °C



31191-211

max 138 °C

No. \varnothing 2.4 mm shaft

No. \varnothing 4 mm shaft

Monopolar electrodes

Reusable, shaft \varnothing 2.4 mm and shaft \varnothing 4 mm

Ball electrode, straight, \varnothing 4 mm, length 110 mm



No. 21191-128

No. 21191-028



= 1

4.3 kVp

max 95 °C



31191-211

max 138 °C

Ball electrode, straight, \varnothing 5 mm, length 110 mm



No. 21191-166

No. 21191-066



= 1

4.3 kVp

max 95 °C



31191-211

max 138 °C

Ball electrode, straight, \varnothing 6 mm, length 115 mm



No. 21191-129

No. 21191-029



= 1

4.3 kVp

max 95 °C



31191-211

max 138 °C

Ball electrode, bent, \varnothing 2 mm, length 35 mm



No. 21191-126

No. 21191-026



= 5

4.3 kVp

max 95 °C



31191-211

max 138 °C

Ball electrode, bent, \varnothing 4 mm, length 35 mm



No. 21191-127

No. 21191-027



= 5

4.3 kVp

max 95 °C



31191-211

max 138 °C

No. \varnothing 2.4 mm shaft

No. \varnothing 4 mm shaft

Monopolar electrodes

Reusable, shaft \varnothing 2.4 mm and shaft \varnothing 4 mm

Ball electrode, bent, \varnothing 2 mm, length 115 mm



No. 21191-130

No. 21191-030



= 1

1 kVp

max 95 °C



31191-211

max 138 °C

Ball electrode, bent, \varnothing 4 mm, length 115 mm



No. 21191-131

No. 21191-031



= 1

1 kVp

max 95 °C



31191-211

max 138 °C

Ball electrode, bent, \varnothing 8 mm, length 190 mm



No. 21191-132

No. 21191-032



= 1

4.3 kVp

max 95 °C



31191-211

max 138 °C

Ball electrode, bent, \varnothing 10 mm, length 190 mm



No. 21191-133

No. 21191-033



= 1

4.3 kVp

max 95 °C



31191-211

max 138 °C

No. \varnothing 2.4 mm shaft

No. \varnothing 4 mm shaft

Monopolar electrodes

Reusable, shaft \varnothing 2.4 mm and shaft \varnothing 4 mm

Ball electrode, bent, \varnothing 8 mm, length 240 mm



No. 21191-134

No. 21191-034



4.3 kVp

max 95 °C



31191-211

max 138 °C

Wire snare electrode, straight, \varnothing 6 mm, length 40 mm



No. 21191-135

No. 21191-035



4.3 kVp

max 95 °C



31191-211

max 138 °C

Wire snare electrode, straight, \varnothing 12 mm, length 40 mm



No. 21191-136

No. 21191-036



4.3 kVp

max 95 °C



31191-211

max 138 °C

Wire snare electrode, straight, \varnothing 16 mm, length 40 mm



No. 21191-137

No. 21191-037



4.3 kVp

max 95 °C



31191-211

max 138 °C

Ribbon snare electrode, straight, \varnothing 12 mm, length 40 mm



No. 21191-138

No. 21191-038



4.3 kVp

max 95 °C



31191-211

max 138 °C

Ribbon snare electrode, straight, \varnothing 16 mm, length 40 mm



No. 21191-139

No. 21191-039



4.3 kVp

max 95 °C



31191-211

max 138 °C

No. \varnothing 2.4 mm shaft

No. \varnothing 4 mm shaft

Monopolar electrodes

Reusable, shaft \varnothing 2.4 mm and shaft \varnothing 4 mm

Tungsten snare electrode, straight, \varnothing 5 mm, length 105 mm

e.g. for the conization of the cervical portio



No. 21191-140

No. 21191-040



4.3 kVp

max 95 °C



31191-211

max 138 °C

Tungsten snare electrode, straight, \varnothing 10 mm, length 105 mm

e.g. for the conization of the cervical portio



No. 21191-041



4.3 kVp

max 95 °C



31191-211

max 138 °C

Tungsten snare electrode, straight, 5 x 5 mm, length 125 mm

e.g. for the conization of the cervical portio



No. 21191-167

No. 21191-067



1.5 kVp

max 95 °C



31191-211

max 138 °C

Tungsten snare electrode, straight, 6 x 15 mm, length 125 mm

e.g. for the conization of the cervical portio



No. 21191-149

No. 21191-049



1.5 kVp

max 95 °C



31191-211

max 138 °C

Tungsten snare electrode, straight, 10 x 12 mm, length 135 mm

e.g. for the conization of the cervical portio



No. 21191-147

No. 21191-047



1.5 kVp

max 95 °C



31191-211

max 138 °C

Tungsten snare electrode, straight, 10 x 15 mm, length 135 mm

e.g. for the conization of the cervical portio



No. 21191-146

No. 21191-046



1.5 kVp

max 95 °C



31191-211

max 138 °C

No. \varnothing 2.4 mm shaft

No. \varnothing 4 mm shaft

Monopolar electrodes

Reusable, shaft \varnothing 2.4 mm and shaft \varnothing 4 mm

Tungsten snare electrode, straight, 15 x 20 mm, length 140 mm

e.g. for the conization of the cervical portio



No. 21191-148

No. 21191-048



1.5 kVp

max 95 °C



31191-211

max 138 °C

Tungsten snare electrode, straight, \varnothing 10 mm, length 130 mm

e.g. for the conization of the cervical portio



No. 21191-142

No. 21191-042



1.5 kVp

max 95 °C



31191-211

max 138 °C

Tungsten snare electrode, straight, \varnothing 15 mm, length 135 mm

e.g. for the conization of the cervical portio



No. 21191-143

No. 21191-043



1.5 kVp

max 95 °C



31191-211

max 138 °C

Tungsten snare electrode, straight, \varnothing 20 mm, length 140 mm

e.g. for the conization of the cervical portio



No. 21191-144

No. 21191-044



1.5 kVp

max 95 °C



31191-211

max 138 °C

Tungsten snare electrode, straight, \varnothing 25 mm, length 145 mm

e.g. for the conization of the cervical portio



No. 21191-145

No. 21191-045



1.5 kVp

max 95 °C



31191-211

max 138 °C

Tungsten snare electrode, straight, \varnothing 30 mm, length 150 mm

e.g. for the conization of the cervical portio



No. 21191-150

No. 21191-050



1.5 kVp

max 95 °C



31191-211

max 138 °C

No. \varnothing 2.4 mm shaft

No. \varnothing 4 mm shaft

Monopolar electrodes

Reusable, shaft \varnothing 2.4 mm

Small surgical set, \varnothing 2.4 mm

consisting of electrodes 21191-124, 21191-135, 21191-112, 21191-100 and 21191-108



No. 21191-180



= 1

4.3 kVp

max 95 °C



31191-213

max 138 °C

Consisting of	Diameter	Width	Length	No.
Ball electrode, straight	4 mm			21191-124
Wire snare electrode, straight	6 mm			21191-135
Needle electrode, straight	0.8 mm		22 mm	21191-112
Knife electrode, straight		3.4 mm	24 mm	21191-100
Knife electrode, bent		1.5 mm	17 mm	21191-108

Large surgical set, \varnothing 2.4 mm

consisting of 15 monopolar electrodes



No. 21191-181



= 1

4.3 kVp

max 95 °C



31191-213

max 138 °C

Consisting of	Diameter	Width	Length	No.
Ball electrode, straight	2 mm			21191-123
Ball electrode, straight	4 mm			21191-124
Ball electrode, straight	6 mm			21191-125
Ball electrode, bent	4 mm			21191-127
Ribbon snare electrode, straight	12 mm			21191-138
Ribbon snare electrode, straight	16 mm			21191-139
Wire snare electrode, straight	6 mm			21191-135
Wire snare electrode, straight	12 mm			21191-136
Knife electrode, bent		1.5 mm	17 mm	21191-108
Knife electrode, straight		1.5 mm	17 mm	21191-101
Knife electrode, straight		3.4 mm	24 mm	21191-100
Needle electrode, bent	0.8 mm		20 mm	21191-115
Needle electrode, straight	0.8 mm		22 mm	21191-112
Spatula electrode, straight	0.8 mm	3 mm	24 mm	21191-102
Spatula electrode, bent	0.8 mm	3 mm	24 mm	21191-109

Monopolar electrodes

Reusable, shaft \varnothing 4 mm

Small surgical set, \varnothing 4 mm

consisting of sterilizing insert 20191-004 and electrodes 21191-000, 21191-008, 21191-012, 21191-024 and 21191-035

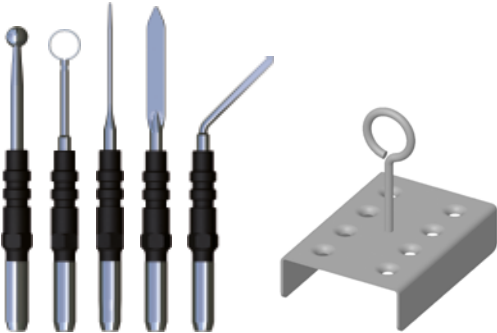

No. 21191-080



= 1

4.3 kVp

max 95 °C



31191-213

max 138 °C

Consisting of	Diameter	Width	Length	No.
Sterilizing insert for 8 electrodes				20191-004
Ball electrode, straight	4 mm			21191-024
Wire snare electrode, straight	6 mm			21191-035
Needle electrode, straight	0.8 mm		22 mm	21191-012
Knife electrode, straight		3.4 mm	24 mm	21191-000
Knife electrode, bent		1.5 mm	17 mm	21191-008

Sterilizing insert for 8 electrodes, 66 x 17 x 46 mm (W x H x D)

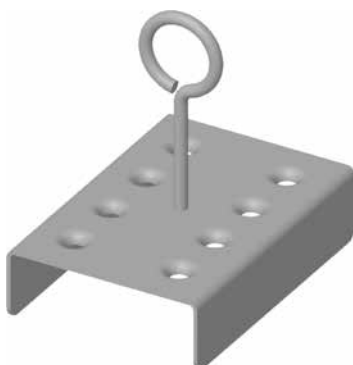

for shaft \varnothing 4 mm

No. 20191-004



= 1

max 95 °C

max 134 °C

Monopolar electrodes

Reusable, shaft \varnothing 4 mm

Large surgical set, \varnothing 4 mm

consisting of sterilization insert 20191-002 and 15 monopolar electrodes



No. 21191-081



= 1

4.3 kVp

max 95 °C



31191-213

max 138 °C

Consisting of	Diameter	Width	Length	No.
Sterilizing insert for 16 electrodes				20191-002
Ball electrode, straight	2 mm			21191-023
Ball electrode, straight	4 mm			21191-024
Ball electrode, straight	6 mm			21191-025
Ball electrode, bent	4 mm			21191-027
Ribbon snare electrode, straight	12 mm			21191-038
Ribbon snare electrode, straight	16 mm			21191-039
Wire snare electrode, straight	6 mm			21191-035
Wire snare electrode, straight	12 mm			21191-036
Knife electrode, bent		1.5 mm	17 mm	21191-008
Knife electrode, straight		1.5 mm	17 mm	21191-001
Knife electrode, straight		3.4 mm	24 mm	21191-000
Needle electrode, bent	0.8 mm		20 mm	21191-015
Needle electrode, straight	0.8 mm		22 mm	21191-012
Spatula electrode, straight	0.8 mm	3 mm	24 mm	21191-002
Spatula electrode, bent	0.8 mm	3 mm	24 mm	21191-009

Sterilizing insert for 16 electrodes, 100 x 17 x 67 mm (W x H x D)



for shaft \varnothing 4 mm

No. 20191-002



= 1

max 95 °C

max 134 °C

Monopolar electrodes

Old/new table: reusable, shaft \varnothing 4 mm

\varnothing 4 mm shaft	Old	New	\varnothing 4 mm shaft	Old	New
Tungsten snare electrode	20191-200	21191-041	Ball electrode	20191-225	21191-026
Tungsten snare electrode	20191-201	21191-040	Ball electrode	20191-226	21191-027
Ball electrode	20191-202	21191-029	Needle electrode	20191-240	21191-013
Ball electrode	20191-203	21191-028	Needle electrode	20191-251	21191-022
Knife electrode	20191-204	21191-010	Tungsten snare electrode	20191-252	21191-042
Knife electrode	20191-205	21191-011	Tungsten snare electrode	20191-253	21191-043
Needle electrode	20191-206	21191-020	Tungsten snare electrode	20191-254	21191-044
Needle electrode	20191-207	21191-021	Tungsten snare electrode	20191-255	21191-045
Knife electrode	20191-208	21191-000	Spatula electrode	20191-274	21191-003
Knife electrode	20191-209	21191-001	Tungsten snare electrode	20191-291	21191-047
Spatula electrode	20191-210	21191-002	Tungsten snare electrode	20191-292	21191-048
Needle electrode	20191-211	21191-012	Tungsten snare electrode	20191-293	21191-049
Knife electrode	20191-212	21191-008	Spatula electrode	20191-337	21191-004
Spatula electrode	20191-213	21191-009	Spatula electrode	20191-338	21191-005
Needle electrode	20191-214	21191-015	Spatula electrode	20191-339	21191-006
Wire snare electrode	20191-215	21191-035	Spatula electrode	20191-340	21191-007
Wire snare electrode	20191-216	21191-036	Tungsten needle electrode	20191-362	21191-016
Wire snare electrode	20191-217	21191-037	Tungsten needle electrode	20191-363	21191-017
Ribbon snare electrode	20191-218	21191-038	Tungsten needle electrode	20191-364	21191-018
Ribbon snare electrode	20191-219	21191-039	Tungsten needle electrode	20191-365	21191-019
Ball electrode	20191-221	21191-023	Spatula electrode	20191-373	21191-056
Ball electrode	20191-222	21191-024	Tungsten snare electrode	20191-412	21191-050
Ball electrode	20191-223	21191-025	Needle electrode	20191-414	21191-051

Old/new table: reusable, shaft \varnothing 2.4 mm

\varnothing 2.4 mm shaft	Old	New
Ball electrode	20191-389	21191-123
Needle electrode	20191-390	21191-112
Spatula electrode	20191-391	21191-153
Spatula electrode	20191-392	21191-159

The design of the new 2.4 mm and 4 mm electrodes has been optimized. New order numbers apply. The old/new tables are effective immediately.

Monopolar electrodes

Single-use, shaft \varnothing 2.4 mm

Spatula electrode, straight, 2.3 x 19 mm, length 45 mm



No. 21191-359

= 50

4.3 kVp

31191-354



STERILE EO

Spatula electrode, straight, insulated, 2.3 x 19 mm, length 45 mm



No. 21191-361

= 20

4.3 kVp

31191-354



STERILE EO

Spatula electrode, straight, 2.3 x 19 mm, length 120 mm



No. 21191-353

= 10

4.3 kVp

31191-354



STERILE EO

Needle electrode, straight, \varnothing 0.8 x 22 mm, length 40 mm



No. 21191-312

= 50

4.3 kVp

31191-354



STERILE EO

Needle electrode, straight, insulated, \varnothing 0.8 x 22 mm, length 40 mm



No. 21191-368

= 20

4.3 kVp

31191-354



STERILE EO

Tungsten needle electrode, straight, insulated, \varnothing 0.5 x 3 mm, length 40 mm

e.g. for precise skin incisions



No. 21191-316

= 20

4.3 kVp



STERILE EO

Needle electrode, straight, \varnothing 0.8 x 15 mm, length 120 mm



No. 21191-320

= 10

4.3 kVp

31191-354



STERILE EO

Monopolar electrodes

Single-use, shaft \varnothing 2.4 mm

Ball electrode, straight, \varnothing 3 mm, length 40 mm



No. 21191-363

= 50

4.3 kVp

31191-354



STERILE EO

Ball electrode, straight, \varnothing 4 mm, length 40 mm



No. 21191-324

= 50

4.3 kVp

31191-354



STERILE EO

Ball electrode, straight, \varnothing 5 mm, length 40 mm



No. 21191-364

= 50

4.3 kVp

31191-354



STERILE EO

Ball electrode, straight, \varnothing 3 mm, length 110 mm



No. 21191-365

= 10

4.3 kVp

31191-354



STERILE EO

Ball electrode, straight, \varnothing 4 mm, length 110 mm



No. 21191-328

= 10

4.3 kVp

31191-354



STERILE EO

Ball electrode, straight, \varnothing 5 mm, length 110 mm



No. 21191-366

= 10

4.3 kVp

31191-354



STERILE EO

Monopolar electrodes

Single-use, shaft \varnothing 2.4 mm

Wire snare electrode, straight, \varnothing 6 mm



No. 21191-335

= 20

4.3 kVp

31191-354



STERILE EO

Wire snare electrode, straight, \varnothing 12 mm



No. 21191-336

= 20

4.3 kVp

31191-354



STERILE EO

Tungsten snare electrode, straight, \varnothing 10 mm, length 130 mm

e.g. for the conization of the cervical portio



No. 21191-342

= 10

1.5 kVp

31191-354



STERILE EO

Tungsten snare electrode, straight, \varnothing 15 mm, length 135 mm

e.g. for the conization of the cervical portio



No. 21191-343

= 10

1.5 kVp

31191-354



STERILE EO

Tungsten snare electrode, straight, \varnothing 20 mm, length 140 mm

e.g. for the conization of the cervical portio



No. 21191-344

= 10

1.5 kVp

31191-354



STERILE EO

Monopolar electrodes

Single-use, shaft \varnothing 2.4 mm

Tungsten snare electrode, straight, 6 x 15 mm, length 125 mm

e.g. for the conization of the cervical portio



No. 21191-349

= 10

1.5 kVp

31191-354



STERILE EO

Tungsten snare electrode, straight, 10 x 12 mm, length 135 mm

e.g. for the conization of the cervical portio



No. 21191-347

= 10

1.5 kVp

31191-354



STERILE EO

Old/new table: single-use, shaft \varnothing 2.4 mm

\varnothing 2.4 mm shaft	Old	New	\varnothing 2.4 mm shaft	Old	New
Needle electrode	20191-377	21191-312	Spatula electrode	20191-376	21191-359
Tungsten snare electrode	20191-385	21191-342	Ball electrode	20191-378	21191-363
Tungsten snare electrode	20191-386	21191-343	Ball electrode	20191-382	21191-365
Tungsten snare electrode	20191-387	21191-344	Ball electrode	20191-383	21191-366
Tungsten snare electrode	20191-384	21191-347	Spatula electrode	20191-379	21191-353

The design of the new 2.4 mm and 4 mm electrodes has been optimized. New order numbers apply. The old/new tables are effective immediately.

Monopolar electrodes

Single-use, shaft \varnothing 2.4 mm

Coated spatula electrode, straight, 2.3 x 19 mm, length 50 mm



No. 21191-459

= 10

4 kVp

D132530



STERILE EO

Coated spatula electrode, straight, isolated, 2.3 x 19 mm, length 50 mm



No. 21191-461

= 10

4 kVp

D132530



STERILE EO

Coated spatula electrode, straight, 2.3 x 19 mm, length 83 mm



No. 21191-453

= 10

4 kVp

D132530



STERILE EO

Coated spatula electrode, straight, isolated, 2.3 x 19 mm, length 83 mm



No. 21191-455

= 10

4 kVp

D132530



STERILE EO

Coated spatula electrode, straight, 2.3 x 19 mm, length 134 mm



No. 21191-457

= 10

4 kVp

D132530



STERILE EO

Coated spatula electrode, straight, isolated, 2.3 x 19 mm, length 134 mm



No. 21191-458

= 10

4 kVp

D132530



STERILE EO

Monopolar electrodes

Single-use, shaft \varnothing 2.4 mm

Coated needle electrode, straight, \varnothing 0.9 x 16 mm, length 50 mm



No. 21191-412

= 10

4 kVp

D132530



STERILE EO

Coated needle electrode, straight, isolated, \varnothing 0.9 x 16 mm, length 50 mm



No. 21191-468

= 10

4 kVp

D132530



STERILE EO

Coated needle electrode, straight, \varnothing 0.9 x 16 mm, length 83 mm



No. 21191-420

= 10

4 kVp

D132530



STERILE EO

Coated needle electrode, straight, isolated, \varnothing 0.9 x 16 mm, length 83 mm



No. 21191-469

= 10

4 kVp

D132530



STERILE EO

Coated needle electrode, straight, \varnothing 0.9 x 16 mm, length 134 mm



No. 21191-470

= 10

4 kVp

D132530



STERILE EO

Coated needle electrode, straight, isolated, \varnothing 0.9 x 16 mm, length 134 mm



No. 21191-473

= 10

4 kVp

D132530



STERILE EO

Monopolar electrodes

Single-use, shaft \varnothing 2 mm, for arthroscopy

Needle electrode, needle angled 90°, needle length 2.5 mm, length 110 mm



No. 20191-331

= 5	4 kVp
	max 95 °C
30191-838	max 134 °C

Needle electrode, needle angled 90°, needle length 2.5 mm, length 170 mm



No. 20191-332

= 5	4 kVp
	max 95 °C
30191-838	max 134 °C

Knife electrode, knife cranked 45°, length 110 mm



No. 20191-333

= 5	4 kVp
	max 95 °C
30191-838	max 134 °C

Knife electrode, knife cranked 45°, length 170 mm



No. 20191-334

= 5	4 kVp
	max 95 °C
30191-838	max 134 °C

Coagulation electrode, tip angled 90°, length 110 mm



No. 20191-335

= 5	4 kVp
	max 95 °C
30191-838	max 134 °C

Coagulation electrode, tip angled 90°, length 170 mm



No. 20191-336

= 5	4 kVp
	max 95 °C
30191-838	max 134 °C

Monopolar electrodes

Extensions, chucks, cleaning pad

Shaft extension, \varnothing 4 mm, shaft insulated, length 40 mm



No. 20191-358



= 1

4 kVp

max 95 °C



30191-682

max 134 °C

Shaft extension, \varnothing 4 mm, shaft insulated, length 100 mm



No. 20191-237



= 1

4 kVp

max 95 °C



30191-682

max 134 °C

Shaft extension, \varnothing 4 mm, shaft insulated, length 150 mm



No. 20191-238



= 1

4 kVp

max 95 °C



30191-682

max 134 °C

Shaft extension, \varnothing 4 mm, shaft insulated, length 180 mm



No. 20191-239



= 1

4 kVp

max 95 °C



30191-682

max 134 °C

Shaft extension, \varnothing 2.4 mm, shaft insulated, length 40 mm



No. 20191-359



= 1

4 kVp

max 95 °C



30191-682

max 134 °C

Cleaning pad for electrodes, with adhesive film, 50 x 50 mm



No. 20191-415



= 100



30191-646

STERILE EO

Monopolar instruments

Instruments for MIS

Hook electrode, flat, ø 5 mm, shaft insulated, length 350 mm

incl. electro-surgical pencil with 2 buttons



No. 20191-179



= 1

3.6 kVp

max 95 °C



30191-741

max 138 °C

Hook electrode, round, ø 5 mm, shaft insulated, length 320 mm

incl. electro-surgical pencil with 2 buttons



No. 20191-184



= 1

4.3 kVp

max 95 °C



30191-314

max 138 °C

Monopolar connecting cables	Connection	Length	Piece	No.
Monopolar connecting cable, VIO, ICC, ACC, Standard, for electro-surgical pencils 20190-045, 20190-082	Standard (MO 9/5 mm)	4 m	1	20192-127 20192-094
	Standard (MO 9/5 mm)	5 m	1	
Monopolar connecting cable, Martin Standard, 4 m, for electro-surgical pencils 20190-045, 20190-082	Martin Standard	4 m	1	20192-099
Monopolar connecting cable, VIO, ICC, ACC, International, 4 m, for electro-surgical pencils 20190-045, 20190-082	International	4 m	1	20192-110

Monopolar instruments

Instruments for MIS

Hook electrode, round, \varnothing 5 mm, shaft insulated, length 320 mm

with non-adhesive coating

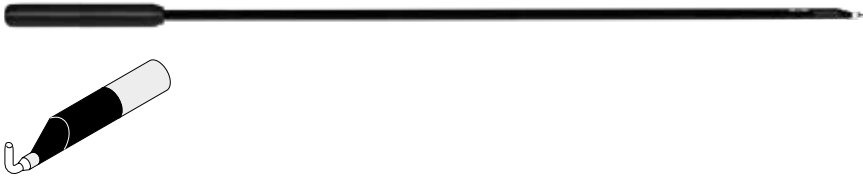

No. 20191-157



4,3 kVp

max 95 °C



30191-314

max 134 °C

Hook electrode, flat, J-shaped, \varnothing 5 mm, shaft insulated, length 320 mm

with non-adhesive coating



No. 20191-174



4,3 kVp

max 95 °C



30191-314

max 134 °C

Hook electrode, flat, L-shaped, \varnothing 5 mm, shaft insulated, length 320 mm

with non-adhesive coating



No. 20191-161



4,3 kVp

max 95 °C



30191-314

max 134 °C

Monopolar connecting cables	Connection	Length	Piece	No.
Monopolar connecting cable, VIO, ICC, ACC, Standard, 4 m, for CUT and COAG MIS instruments, with connection \varnothing 4 mm	Standard (MO 9/5 mm)	4 m	1	20192-104
Monopolar connecting cable, Martin Standard, 4 m, for CUT and COAG MIS instruments, with connection \varnothing 4 mm	Martin Standard	4 m	1	20192-108
Monopolar connecting cable, VIO, ICC, ACC, International \varnothing 8 mm (Bovie Jack), 4 m, for CUT and COAG MIS instruments, with connection \varnothing 4 mm	International \varnothing 8 mm (Bovie Jack)	4 m	1	20192-113
Monopolar connecting cable, 3-Pin, \varnothing 4 mm socket, length 4.5 m for CUT and COAG MIS instruments, with connection \varnothing 4 mm	International (3-Pin)	4.5 m	1	20192-133

Important information

We have prepared this document with care. Nonetheless, we cannot completely rule out errors in this document.

The information, recommendations and other data („Information“) contained in this document reflect our state of knowledge and the state of science and technology at the time of preparing the document. The information is of a general nature, non-binding and serves solely for general information purposes and does not represent instructions for use or notes on application.

The information and recommendations contained in this document do not constitute any legal obligations by Erbe Elektromedizin GmbH as well as their associated companies („Erbe“) or any other claims against Erbe. The information does not represent a guarantee or other quality statement, these require the express contractual arrangement with Erbe in individual cases. Erbe shall not be liable for any type of damage resulting from following information given in this document, regardless of the legal reason for liability.

Every user of an Erbe product is responsible for checking the respective Erbe product for its properties as well as the suitability for the intended type of application or intended purpose in advance. The suitable type of application of the respective Erbe product is given by the user manual and the notes on use for the corresponding Erbe product. The user is obliged to check whether the existing user manual and the notes on use correspond with the status for the specific Erbe product. The devices may only be used according to the user manual and the notes on use.

The information on setting values, application sites, duration of application and the use of the respective Erbe product is based on the clinical experience of physicians independent from Erbe. They represent guidelines which need to be checked by the user for their suitability for the actual planned application. Depending on the circumstances of an actual application case, it may be necessary to deviate from the information provided. The user has to check this on his/her own responsibility in each case when using an Erbe product. We wish to point out that science and technology is constantly subject to new developments arising from research and clinical experience. For this reason it may be necessary for the user to deviate from the information provided in this document.

This document contains information about Erbe products which may possibly not be approved in a specific country. The user of the respective Erbe product is obliged to inform him/herself whether the Erbe product he/she is using is legally approved in his/her country and/or if legal requirements or restrictions for use possibly exist and to which extent.

This document is not intended for users in the USA.

Erbe Elektromedizin GmbH
Waldhoernlestrasse 17
72072 Tuebingen
Germany

Phone +49 7071 755-0
Fax +49 7071 755-179
info@erbe-med.com
erbe-med.com



Monopolar
electrosurgical
pencils

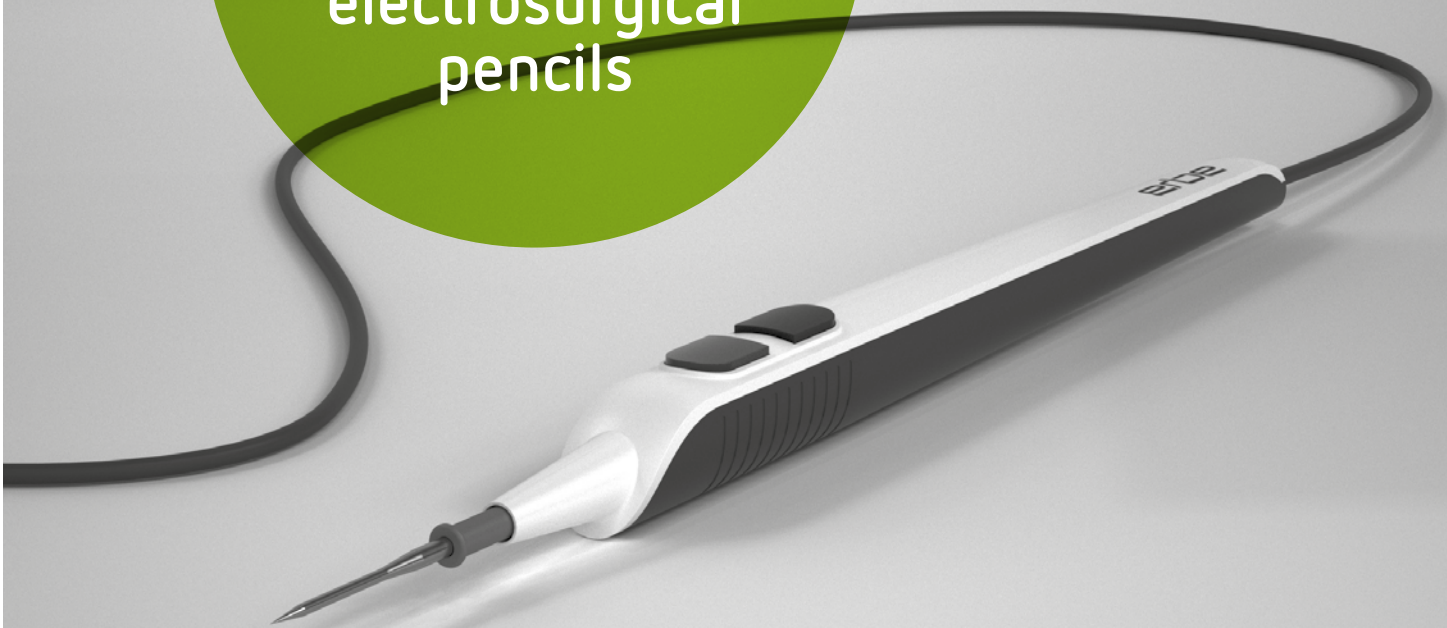

Legend

Important notes

The authors and Erbe Elektromedizin GmbH have taken the greatest possible care while compiling the catalogue with electrosurgical accessories. Nevertheless, it is impossible to exclude the possibility that errors may be contained herein.

The information and recommendations given here may not be construed as constituting any basis for any claims against Erbe Elektromedizin GmbH. Should legal regulations stipulate liability, such liability shall be limited to intentional misconduct or gross negligence.

The data on the use of instruments is based on clinical experience. Medical science is subject to a process of permanent change based on research and clinical experience. Therefore the products are subject to alterations in design and technique. Because of production tolerances dimensions in the catalogue may marginally differ.

We confirm that none of our products contain latex, except the rubber straps, Art. No. 20592-009 and 20592-011.

Further product information

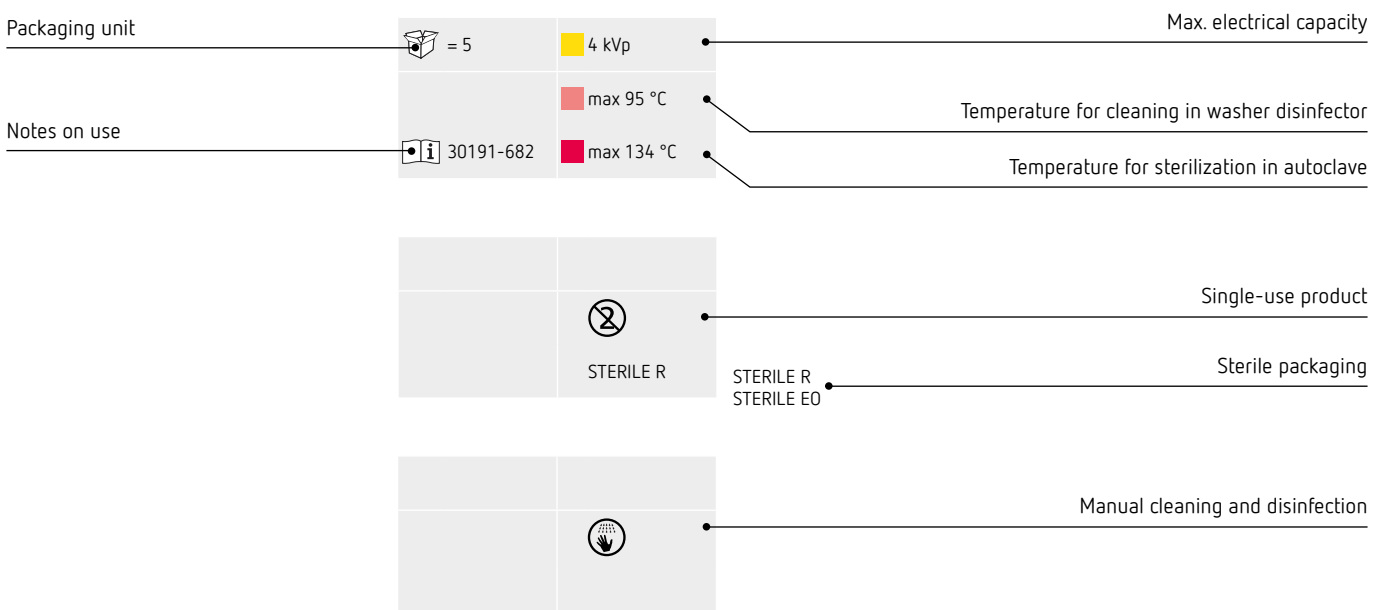

Please read carefully the corresponding notes on use before using any instrument.

Electrosurgery

Monopolar electrosurgical pencils

04	Electrosurgical single-use pencils (ø 2.4 mm)	11	Electrosurgical pencils for smoke evacuation
07	Premium electrosurgical pencils (ø 2.4 mm)	13	Electrosurgical pencils for arthroscopy (ø 2 mm)
08	Premium electrosurgical pencils (ø 4 mm)	13	Electrosurgical pencils for nerve test
10	ECO-LINE electrosurgical pencils (ø 2.4 mm)		

Monopolar electrosurgical pencils

ø 2,4

Electrosurgical single-use pencils (ø 2.4 mm)

Electrosurgical single-use pencil, button switch, spatula electrode, connecting cable 3 m



No. 20190-160

= 25

5 kVp

D140175



STERILE EO

Electrosurgical single-use pencil, button switch, spatula electrode, holster, connecting cable 3 m



No. 20190-161

= 25

5 kVp

D140175



STERILE EO

Electrosurgical single-use pencil, rocker switch, spatula electrode, connecting cable 3 m



No. 20190-162

= 25

5 kVp

D140175



STERILE EO

Electrosurgical single-use pencil, rocker switch, spatula electrode, holster, connecting cable 3 m



No. 20190-163

= 25

5 kVp

D140175



STERILE EO

Electrosurgical single-use pencil, button switch, needle electrode, connecting cable 3 m



No. 20190-165

= 25

5 kVp

D140175



STERILE EO

Monopolar electrosurgical pencils

ø 2,4

Electrosurgical single-use pencils (ø 2.4 mm)

Electrosurgical single-use pencil, button switch, needle electrode, holster, connecting cable 3 m



No. 20190-166

= 25

5 kVp

D140175



STERILE EO



No. 20190-167

= 25

5 kVp

D140175



STERILE EO

Electrosurgical single-use pencil, rocker switch, needle electrode, holster, connecting cable 3 m



No. 20190-168

= 25

5 kVp

D140175



STERILE EO

Electrosurgical single-use pencil, button switch, spatula electrode, connecting cable 5 m



No. 20190-169

= 25

5 kVp

D140175



STERILE EO

Electrosurgical single-use pencil, rocker switch, spatula electrode, connecting cable 5 m



No. 20190-170

= 25

5 kVp

D140175



STERILE EO

Monopolar electrosurgical pencils

ø 2,4

Electrosurgical single-use pencils (ø 2.4 mm)

Electrosurgical pencil with 2 buttons, VIO, ICC, ACC, non-Erbe units, International

with connecting cable 3 m, with needle electrode



No. 20190-117

= 10

4.3 kVp

30190-259



STERILE R

Electrosurgical pencil with 2 buttons, VIO, ICC, ACC, non-Erbe units, International

with connecting cable 3 m, with spatula electrode without protective holster



No. 20190-106

= 10

4.3 kVp

30190-212



STERILE R

Electrosurgical pencil with 2 buttons, VIO, ICC, ACC, non-Erbe units, International

with connecting cable 3 m, with spatula electrode and protective holster



No. 20190-107

= 30

4.3 kVp

30190-212



STERILE R

Electrosurgical pencil with rocker switch, VIO, ICC, ACC, non-Erbe units, International

with connecting cable 3 m, with spatula electrode without protective holster



No. 20190-109

= 10

4.3 kVp

30190-212



STERILE R

Electrosurgical pencil with rocker switch, VIO, ICC, ACC, non-Erbe units, International

with connecting cable 3 m, with spatula electrode and protective holster



No. 20190-108

= 30

4.3 kVp

30190-212



STERILE R

Monopolar adapters for electrosurgical pencils with connecting plug International

Monopolar Adapter, VIO, ICC, ACC, Standard (MO 9/5 mm), for connecting plug international (3 Pin)



Connection

Standard (MO 9/5 mm)

Piece

1

No.

20183-028

Monopolar electro-surgical pencils

ø 2,4

Premium electro-surgical pencils (ø 2.4 mm)

Slim-Line electro-surgical pencil with 2 buttons, VIO, ICC, ACC, Standard

with connecting cable 4 m



No. 20190-105



= 1

4 kVp

max 95 °C



30190-179

max 138 °C

Slim-Line electro-surgical pencil with 2 buttons, VIO, ICC, ACC, non-Erbe units, International

with connecting cable 4 m



No. 20190-067



= 1

6 kVp

max 95 °C



30190-179

max 138 °C

Slim-Line electro-surgical pencil with rocker switch, VIO, ICC, ACC, Standard

with connecting cable 4 m



No. 20190-104



= 1

4 kVp

max 95 °C



30190-179

max 138 °C

Slim-Line electro-surgical pencil with rocker switch, VIO, ICC, ACC, non-Erbe units, International

with connecting cable 4 m



No. 20190-076



= 1

6 kVp

max 95 °C



30190-179

max 138 °C

Monopolar electrosurgical pencils

Ø 4

Premium electrosurgical pencils (Ø 4 mm)

Slim-Line electrosurgical pencil with 2 buttons, VIO, ICC, ACC, Standard

with connecting cable 4 m



No. 20190-065



= 1

4 kVp

max 95 °C



30190-179

max 138 °C

Slim-Line electrosurgical pencil with 2 buttons, VIO, ICC, ACC, non-Erbe units, International

with connecting cable 4 m



No. 20190-066



= 1

6 kVp

max 95 °C



30190-179

max 138 °C

Slim-Line electrosurgical pencil with rocker switch, VIO, ICC, ACC, Standard

with connecting cable 4 m



No. 20190-074



= 1

4 kVp

max 95 °C



30190-179

max 138 °C

Slim-Line electrosurgical pencil with rocker switch, VIO, ICC, ACC, non-Erbe units, International

with connecting cable 4 m



No. 20190-075



= 1

6 kVp

max 95 °C



30190-179

max 138 °C

Electrosurgical pencil with 2 buttons, VIO, ICC, ACC, non-Erbe units, International

with connecting cable 4 m



No. 20190-062



= 1

4.3 kVp

max 95 °C



30190-179

max 138 °C

Monopolar electro-surgical pencils

ø 4

Premium electro-surgical pencils (ø 4 mm)

Electrosurgical pencil with 2 buttons, VIO, ICC, ACC, Standard / International

without connecting cable



No. 20190-045



= 1

4.3 kVp

max 95 °C



30190-179

max 138 °C

Monopolar connecting cables

Monopolar connecting cable, VIO, ICC, ACC, Standard, for electro-surgical pencil 20190-045, 20190-082



Connection

Standard (MO 9/5 mm)
Standard (MO 9/5 mm)

Length

4 m
5 m

Piece

1
1

No.

20192-127
20192-094

Monopolar connecting cable, Martin Standard, 4 m, for electro-surgical pencil 20190-045, 20190-082



Martin Standard

4 m

1

20192-099

Monopolar connecting cable, VIO, ICC, ACC, International, 4 m, for electro-surgical pencil 20190-045, 20190-082



International

4 m

1

20192-110

Slim-Line electro-surgical pencil with rocker switch, VIO, ICC, ACC, Standard

with connecting cable 4 m, with extension 70 mm



No. 20190-090



= 1

2.5 kVp

max 95 °C



30190-179

max 138 °C

Slim-Line electro-surgical pencil with rocker switch, VIO, ICC, ACC, non-Erbe units, International

with connecting cable 4 m, with extension 70 mm



No. 20190-093



= 1

2.5 kVp

max 95 °C



30190-179

max 138 °C

Monopolar electrosurgical pencils

ø 2,4

ECO-LINE electrosurgical pencils (ø 2.4 mm)

ECO-Line electrosurgical pencil with 2 buttons, VIO, ICC, ACC, non-Erbe units, International

with connecting cable 4 m



No. 20190-111



= 1

5 kVp

max 95 °C



30190-255

max 138 °C

ECO-Line electrosurgical pencil with rocker switch, VIO, ICC, ACC, non-Erbe units, International

with connecting cable 4 m



No. 20190-112



= 1

5 kVp

max 95 °C



30190-255

max 138 °C

Monopolar adapters for electrosurgical pencils with connecting plug International	Connection	Piece	No.
Monopolar Adapter, VIO, ICC, ACC, Standard (MO 9/5 mm), for connecting plug international (3 Pin) 	Standard (MO 9/5 mm)	1	20183-028

Monopolar electrosurgical pencils

Electrosurgical pencils for smoke evacuation

Smoke evacuation pencil, single use, short with spatula electrode, connecting cable 3 m



No. 20321-040

= 20

4.5 kVp

D150123



STERILE EO

Smoke evacuation pencil, single use, short with coated spatula electrode, connecting cable 3 m



No. 20321-041

= 20

4.5 kVp

D150123



STERILE EO

Smoke evacuation pencil, single use, short with spatula electrode, connecting cable 5 m



No. 20321-042

= 20

4.5 kVp

D150123



STERILE EO

Smoke evacuation pencil, single use, short with coated spatula electrode, connecting cable 5 m



No. 20321-043

= 20

4.5 kVp

D150123



STERILE EO

Electrosurgical pencil with 2 buttons, VIO, ICC, ACC, ø 10 / 22 mm, International

with connecting cable 3 m, with spatula electrode and integrated smoke evacuationshaft extension 100 mm.

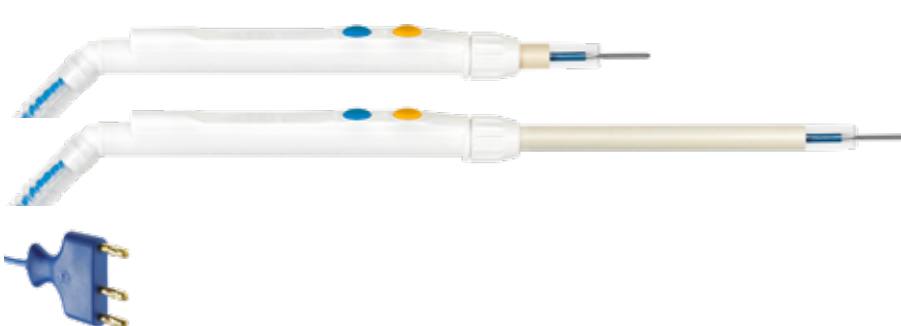

No. 20321-028

= 25

4.5 kVp

30321-001



STERILE EO

Monopolar electrosurgical pencils

Electrosurgical pencils for smoke evacuation

Clip-on handle for smoke evacuation for 20190-065, -066, -067, -074, -075, -090, -093, -104, -105

To be used in combination with Erbe Slim-Line electrosurgical pencils (20190-065, 20190-066, 20190-067, 20190-074, 20190-075, 20190-090, 20190-093, 20190-104, 20190-105)



No. 20321-044

= 20

D150128



STERILE EO

Extension tip for Clip-on handle 20321-044

To be used in combination with 20321-044



No. 20321-045

= 25

D146678



STERILE EO

Clip-on handle for Slim-Line electrosurgical pencils, tip short 12 mm

with evacuation tubing 3 m and connection \varnothing 22 mm, without electrosurgical pencil



No. 20321-007

= 25

30321-000



STERILE EO

Clip-on handle for Slim-Line electrosurgical pencils, tip long 100 mm

with evacuation tubing 3 m and connection \varnothing 22 mm, without electrosurgical pencil



No. 20321-020

= 25

30321-000



STERILE EO

Monopolar electrosurgical pencils

ø 2

Electrosurgical pencils for arthroscopy (ø 2 mm)

Electrosurgical pencil with 2 buttons, VIO, ICC, ACC, Standard / International

without connecting cable



No. 20190-082



= 1

4 kVp

max 95 °C



30190-196

max 138 °C

Monopolar connecting cables

Monopolar connecting cable, VIO, ICC, ACC, Standard



Connection

Standard (MO 9/5 mm)
Standard (MO 9/5 mm)

Length

4 m
5 m

Piece

1
1

No.

20192-127
20192-094

Monopolar connecting cable, VIO, ICC, ACC, International



International

4 m

1

20192-110

Electrosurgical pencil with 2 buttons, VIO, ICC, ACC, non-Erbe units, International

with connecting cable 4 m



No. 20190-098



= 1

4 kVp

max 95 °C



30190-196

max 138 °C

Electrosurgical pencils for nerve test

Electrosurgical pencil for nerve test with 1 button, for silver ball electrode, NT 2, ICC 350 ZMK

with connecting cable 4 m



No. 20190-148



= 1

0.25 kVp

max 95 °C



30190-262

max 138 °C

Silver ball electrode for nerve test, ø 1 mm, length 40 mm



Shape / Forming

straight

Piece

1

No.

21191-052





Important information

We have prepared this document with care. Nonetheless, we cannot completely rule out errors in this document.

The information, recommendations and other data ("Information") contained in this document reflect our state of knowledge and the state of science and technology at the time of preparing the document. The information is of a general nature, non-binding and serves solely for general information purposes and does not represent instructions for use or notes on application.

The information and recommendations contained in this document do not constitute any legal obligations by Erbe Elektromedizin GmbH as well as their associated companies ("Erbe") or any other claims against Erbe. The information does not represent a guarantee or other quality statement, these require the express contractual arrangement with Erbe in individual cases.

Erbe shall not be liable for any type of damage resulting from following information given in this document, regardless of the legal reason for liability.

Every user of an Erbe product is responsible for checking the respective Erbe product for its properties as well as the suitability for the intended type of application or intended purpose in advance. The suitable type of application of the respective Erbe product is given by the user manual and the notes on use for the corresponding Erbe product. The user is obliged to check whether the existing user manual and the notes on use correspond with the status for the specific Erbe product. The devices may only be used according to the user manual and the notes on use.

The information on setting values, application sites, duration of application and the use of the respective Erbe product is based on the clinical experience of physicians independent from Erbe. They represent guidelines which need to be checked by the user for their suitability for the actual planned application. Depending on the circumstances of an actual application case, it may be necessary to deviate from the information provided. The user has to check this on his/her own responsibility in each case when using an Erbe product. We wish to point out that science and technology is constantly subject to new developments arising from research and clinical experience. For this reason it may be necessary for the user to deviate from the information provided in this document.

This document contains information about Erbe products which may possibly not be approved in a specific country. The user of the respective Erbe product is obliged to inform him/herself whether the Erbe product he/she is using is legally approved in his/her country and/or if legal requirements or restrictions for use possibly exist and to which extent.

This document is not intended for users in the USA.

Erbe Elektromedizin GmbH
Waldhoernlestrasse 17
72072 Tuebingen
Germany

Phone +49 7071 755-0
info@erbe-med.com
erbe-med.com
medical-videos.com

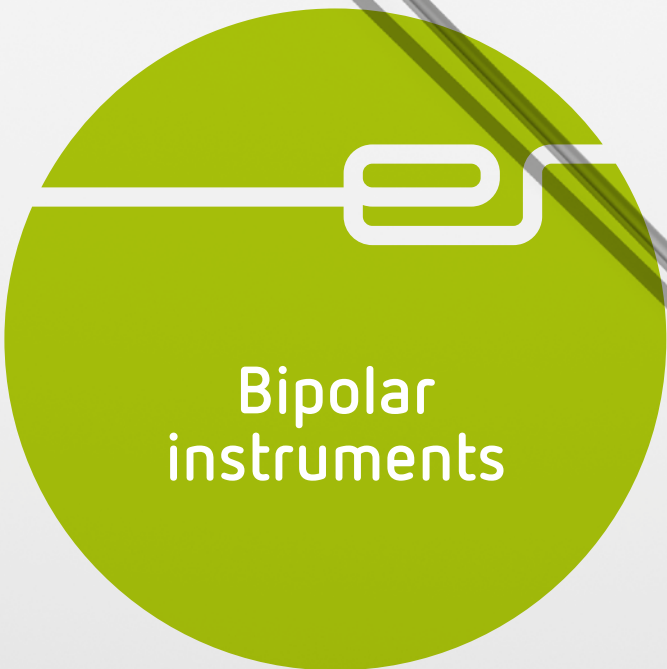

Legend

Important notes

The authors and Erbe Elektromedizin GmbH have taken the greatest possible care while compiling the catalogue with electrosurgical accessories. Nevertheless, it is impossible to exclude the possibility that errors may be contained herein.

The information and recommendations given here may not be construed as constituting any basis for any claims against Erbe Elektromedizin GmbH. Should legal regulations stipulate liability, such liability shall be limited to intentional misconduct or gross negligence.

The data on the use of instruments is based on clinical experience. Medical science is subject to a process of permanent change based on research and clinical experience. Therefore the products are subject to alterations in design and technique. Because of production tolerances dimensions in the catalogue may marginally differ.

We confirm that none of our products contain latex, except the rubber straps, Art. No. 20592-009 and 20592-011.

Further product information

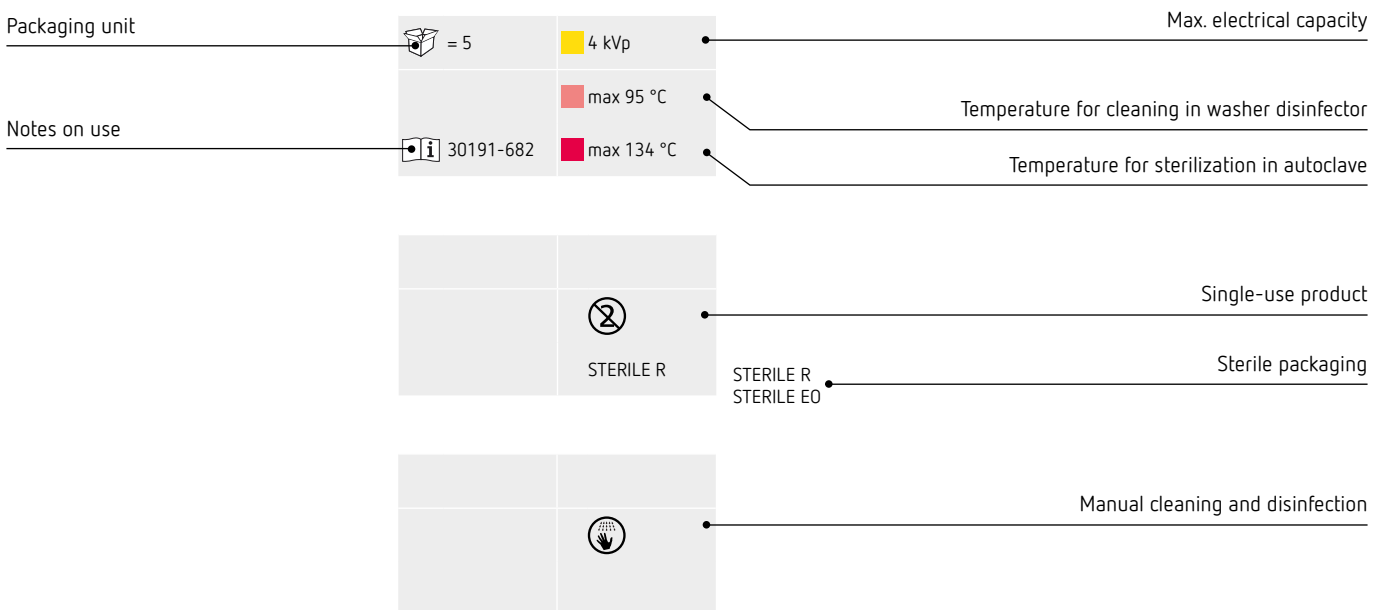

Please read carefully the corresponding notes on use before using any instrument.

Electrosurgery

Bipolar Instruments

04	LAP forceps	10	Contact and puncture electrodes for MIS
06	LAP BiSect and bipolar LAP scissors	10	Contact electrodes
09	BiSect scissors		

Overview

Field of application

Endoscopy / laparoscopy



Open surgery



Type of instrument

Cutting instruments



Coagulation instruments



Bipolar instruments

LAP forceps

Bipolar LAP forceps, Maryland, deep ribbed, shaft \varnothing 5 mm, length 340 mm

consisting of: 20195-140, 20195-141, 20195-143



No. 20195-132

= 1	0.25 kVp
	max 95 °C
30195-119	max 138 °C

Bipolar LAP forceps, fenestrated, deep ribbed, shaft \varnothing 5 mm, length 340 mm

consisting of: 20195-140, 20195-141, 20195-144



No. 20195-133

= 1	0.25 kVp
	max 95 °C
30195-119	max 138 °C

Bipolar E LAP forceps, fenestrated, deep ribbed, shaft \varnothing 5 mm, length 340 mm

consisting of: 20195-245, 20195-241, 20195-144



No. 20195-224

= 1	0.25 kVp
	max 95 °C
30195-119	max 138 °C

Bipolar E LAP forceps, Maryland, deep ribbed, shaft \varnothing 5 mm, length 340 mm

consisting of: 20195-245, 20195-241, 20195-143









No. 20195-225





= 1	0.25 kVp
	max 95 °C
30195-119	max 138 °C

Bipolar instruments

LAP forceps

Single components		Piece	No.
Insert for LAP forceps, Maryland and E LAP forceps, Maryland, deep-ribbed, ø 5 mm, length 340 mm (for 20195-132 and 20195-225)		1	20195-143
Insert for LAP forceps, fenestrated and E LAP forceps, fenestrated deep-ribbed, ø 5 mm, length 340 mm (for 20195-133 and 20195-224)		1	20195-144
Shaft tube for bipolar LAP forceps and BiClamp LAP forceps, ø 5 mm, length 340 mm		1	20195-141
Shaft tube for bipolar E LAP forceps and BiClamp E LAP forceps, ø 5 mm, length 340 mm		1	20195-241
Handle for LAP forceps, without connecting cable		1	20195-140
Handle for E LAP forceps, without connecting cable		1	20195-245

Accessories for treatment		Piece	No.
Cleaning brush, length 650 mm, for manual cleaning and disinfection		1	20191-279
Rinsing tube with Luer Lock connector, length 500 mm, for cleaning and disinfection by machine		1	20195-201

Bipolar connecting cables	Connection	Length	Piece	No.
Bipolar connecting cable, VIO, ICC, ACC, T-Series, Standard 	Standard	4 m	1	20196-045
	Standard	5 m	1	20196-057
Bipolar connecting cable, VIO, ICC, ACC, International (2-Pin 22 mm) 	International	4 m	1	20196-053
	International	5 m	1	20196-061
Bipolar connecting cable, Martin Standard 	Martin Standard	4 m	1	20196-047
	Martin Standard	5 m	1	20196-059
Bipolar connecting cable, Valleylab and non-Erbe units (2-Pin 28 mm) 	Vallylab (2-Pin 28 mm)	4 m	1	20196-055

Bipolar instruments

LAP BiSect and bipolar LAP scissors

LAP BiSect Micro, shaft \varnothing 5 mm, length 350 mm

consisting of: 20195-206, 20195-208, 20195-209, 20195-210



No. 20195-204

= 1

0.475 kVp

max 95 °C

30195-114

max 138 °C

LAP BiSect Macro, shaft \varnothing 5 mm, length 350 mm

consisting of: 20195-207, 20195-208, 20195-209, 20195-210



No. 20195-205

= 1

0.475 kVp

max 95 °C

30195-114

max 138 °C

Single components		Piece	No.
Insert for LAP BiSect Micro (20195-204), \varnothing 5 mm, length 350 mm		1	20195-206
Insert for LAP BiSect Macro (20195-205), \varnothing 5 mm, length 350 mm		1	20195-207
Shaft tube for LAP BiSect Micro and Macro, \varnothing 5 mm, length 350 mm		1	20195-208
Insulated tube for LAP BiSect Micro and Macro, \varnothing 5 mm, length 350 mm		1	20195-209
Handle for LAP BiSect Micro and Macro		1	20195-210

Bipolar instruments

LAP BiSect and bipolar LAP scissors

Bipolar LAP scissors, Metzenbaum, shaft \varnothing 5 mm, length 340 mm

consisting of: 20195-140, 20195-141, 20195-242



No. 20195-226

0.25 kVp

max 95 °C

30195-119 max 138 °C

Bipolar E LAP scissors, Metzenbaum, shaft \varnothing 5 mm, length 340 mm

consisting of: 20195-245, 20195-241, 20195-242



No. 20195-227

0.25 kVp



max 95 °C

30195-119 max 138 °C

Single components		Piece	No.
Insert for bipolar LAP scissors Metzenbaum and bipolar E LAP scissors Metzenbaum, shaft \varnothing 5 mm, length 340 mm (for 20195-226 and 20195-227)		1	20195-242
Shaft tube for bipolar LAP scissors, \varnothing 5 mm, length 340 mm		1	20195-141
Shaft tube for bipolar E LAP scissors, \varnothing 5 mm, length 340 mm		1	20195-241
Handle for LAP scissors, without connecting cable		1	20195-140
Handle for E LAP scissors, without connecting cable		1	20195-245

Bipolar instruments

LAP BiSect and bipolar LAP scissors

Bipolar connecting cables	Connection	Length	Piece	No.
Bipolar connecting cable, VIO, ICC, ACC, T-Series, Standard 	Standard	4 m	1	20196-045
	Standard	5 m	1	
Bipolar connecting cable, VIO, ICC, ACC, International (2-Pin 22 mm) 	International	4 m	1	20196-053
	International	5 m	1	
Bipolar connecting cable, Martin Standard 	Martin Standard	4 m	1	20196-047
	Martin Standard	5 m	1	
Bipolar connecting cable, Vallylab and non-Erbe units (2-Pin 28 mm) 	Vallylab (2-Pin 28 mm)	4 m	1	20196-055

Accessories for treatment		Piece	No.
Cleaning brush, length 650 mm, for manual cleaning and disinfection		1	20191-279
Rinsing tube with Luer Lock connector, length 500 mm, for cleaning and disinfection by machine		1	20195-201

Bipolar instruments

Bipolar scissors BiSect

Bipolar scissors BiSect 180, bent, length 180 mm

incl. protector 20195-193



No. 20195-170



0.6 kVp

max 95 °C



30195-106

max 138 °C

Bipolar scissors BiSect 230, bent, length 230 mm

incl. protector 20195-194



No. 20195-171



0.6 kVp

max 95 °C



30195-106

max 138 °C

Bipolar scissors BiSect 280, bent, length 280 mm

incl. protector 20195-195



No. 20195-172



0.6 kVp

max 95 °C



30195-106

max 138 °C

Protectors for BiSect	Piece	No.
for BiSect 180	1	20195-193
for BiSect 230	1	20195-194
for BiSect 280	1	20195-195

Bipolar connecting cables	Connection	Length	Piece	No.
Bipolar connecting cable, VIO, ICC, ACC, T-Series, Standard	Standard	4 m	1	20196-106
Bipolar connecting cable, VIO, ICC, ACC, International (2-Pin 22 mm)	International	4 m	1	20196-107

Bipolar instruments

Contact and puncture electrodes for MIS

Bipolar puncture coagulation needle, bent 25°, needle length 10 mm, length 100 mm

e.g. for puncture coagulation of the concha nasalis



No. 20195-025



0.5 kVp

max 95 °C



30195-011

max 138 °C

Bipolar connecting cables	Connection	Length	Piece	No.
Bipolar connecting cable, VIO, ICC, ACC, T-Series, Standard	Standard Standard	4 m 5 m	1 1	20196-045 20196-057
Bipolar connecting cable, VIO, ICC, ACC, International (2-Pin 22 mm)	International International	4 m 5 m	1 1	20196-053 20196-061
Bipolar connecting cable, Martin Standard	Martin Standard Martin Standard	4 m 5 m	1 1	20196-047 20196-059
Bipolar connecting cable, Valleylab and non-Erbe units (2-Pin 28 mm)	Vallylab (2-Pin 28 mm)	4 m	1	20196-055

Contact electrodes

Bipolar contact electrode, bent 22.5°, tip angled 45°, length 100 mm



No. 20195-003



0.5 kVp

max 95 °C



30195-011

max 138 °C



Important information

We have prepared this document with care. Nonetheless, we cannot completely rule out errors in this document.

The information, recommendations and other data ("Information") contained in this document reflect our state of knowledge and the state of science and technology at the time of preparing the document. The information is of a general nature, non-binding and serves solely for general information purposes and does not represent instructions for use or notes on application.

The information and recommendations contained in this document do not constitute any legal obligations by Erbe Elektromedizin GmbH as well as their associated companies ("Erbe") or any other claims against Erbe. The information does not represent a guarantee or other quality statement, these require the express contractual arrangement with Erbe in individual cases.

Erbe shall not be liable for any type of damage resulting from following information given in this document, regardless of the legal reason for liability.

Every user of an Erbe product is responsible for checking the respective Erbe product for its properties as well as the suitability for the intended type of application or intended purpose in advance. The suitable type of application of the respective Erbe product is given by the user manual and the notes on use for the corresponding Erbe product. The user is obliged to check whether the existing user manual and the notes on use correspond with the status for the specific Erbe product. The devices may only be used according to the user manual and the notes on use.

The information on setting values, application sites, duration of application and the use of the respective Erbe product is based on the clinical experience of physicians independent from Erbe. They represent guidelines which need to be checked by the user for their suitability for the actual planned application. Depending on the circumstances of an actual application case, it may be necessary to deviate from the information provided. The user has to check this on his/her own responsibility in each case when using an Erbe product. We wish to point out that science and technology is constantly subject to new developments arising from research and clinical experience. For this reason it may be necessary for the user to deviate from the information provided in this document.

This document contains information about Erbe products which may possibly not be approved in a specific country. The user of the respective Erbe product is obliged to inform him/herself whether the Erbe product he/she is using is legally approved in his/her country and/or if legal requirements or restrictions for use possibly exist and to which extent.

This document is not intended for users in the USA.

Erbe Elektromedizin GmbH
Waldhoernlestrasse 17
72072 Tuebingen
Germany

Phone +49 7071 755-0
Fax +49 7071 755-179
info@erbe-med.com
erbe-med.com

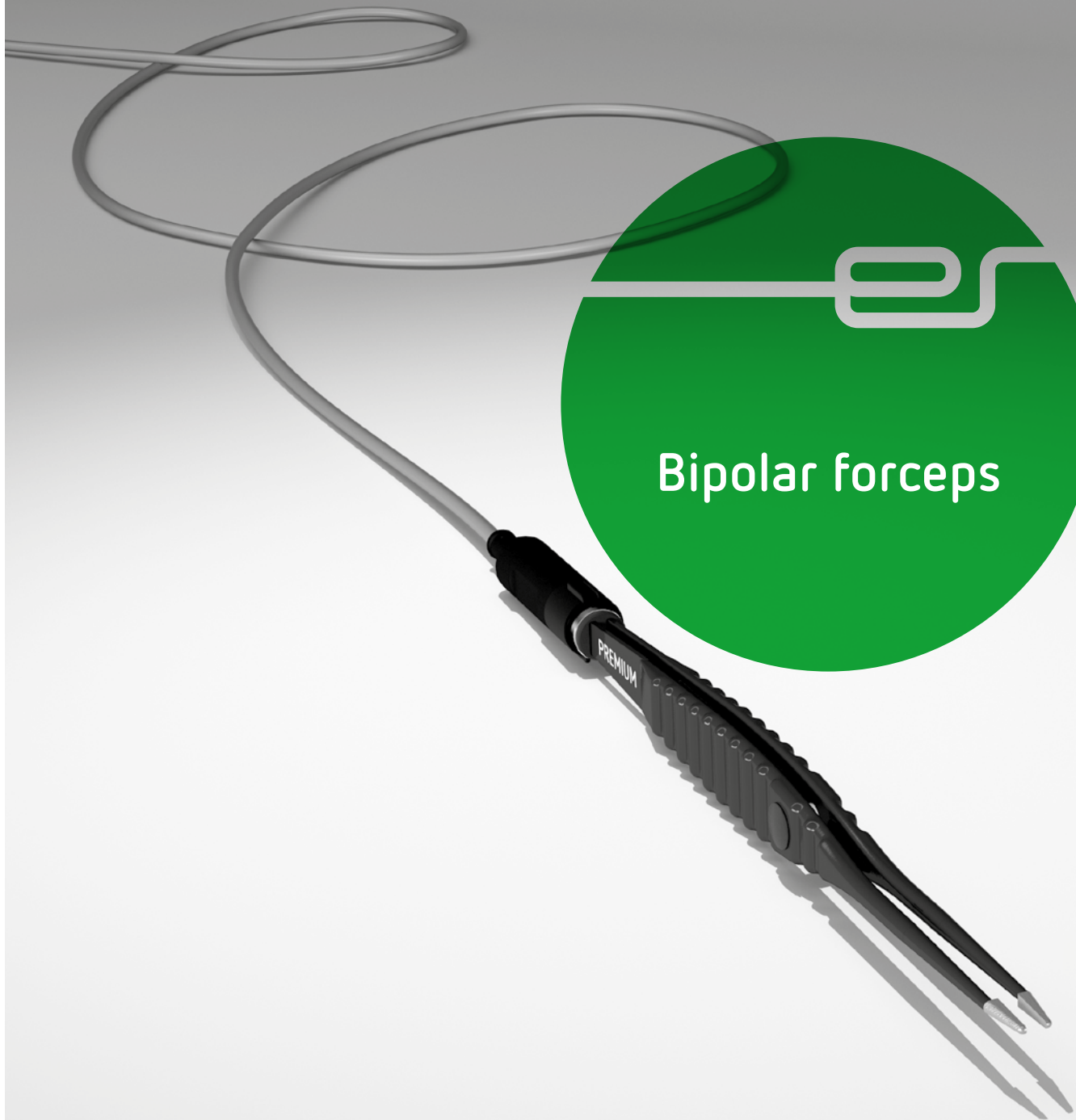

Legend

Important notes

The authors and Erbe Elektromedizin GmbH have taken the greatest possible care while compiling the catalogue with electrosurgical accessories. Nevertheless, it is impossible to exclude the possibility that errors may be contained herein.

The information and recommendations given here may not be construed as constituting any basis for any claims against Erbe Elektromedizin GmbH. Should legal regulations stipulate liability, such liability shall be limited to intentional misconduct or gross negligence.

The data on the use of instruments is based on clinical experience. Medical science is subject to a process of permanent change based on research and clinical experience. Therefore the products are subject to alterations in design and technique. Because of production tolerances dimensions in the catalogue may marginally differ.

We confirm that none of our products contain latex, except the rubber straps, Art. No. 20592-009 and 20592-011.

Further product information

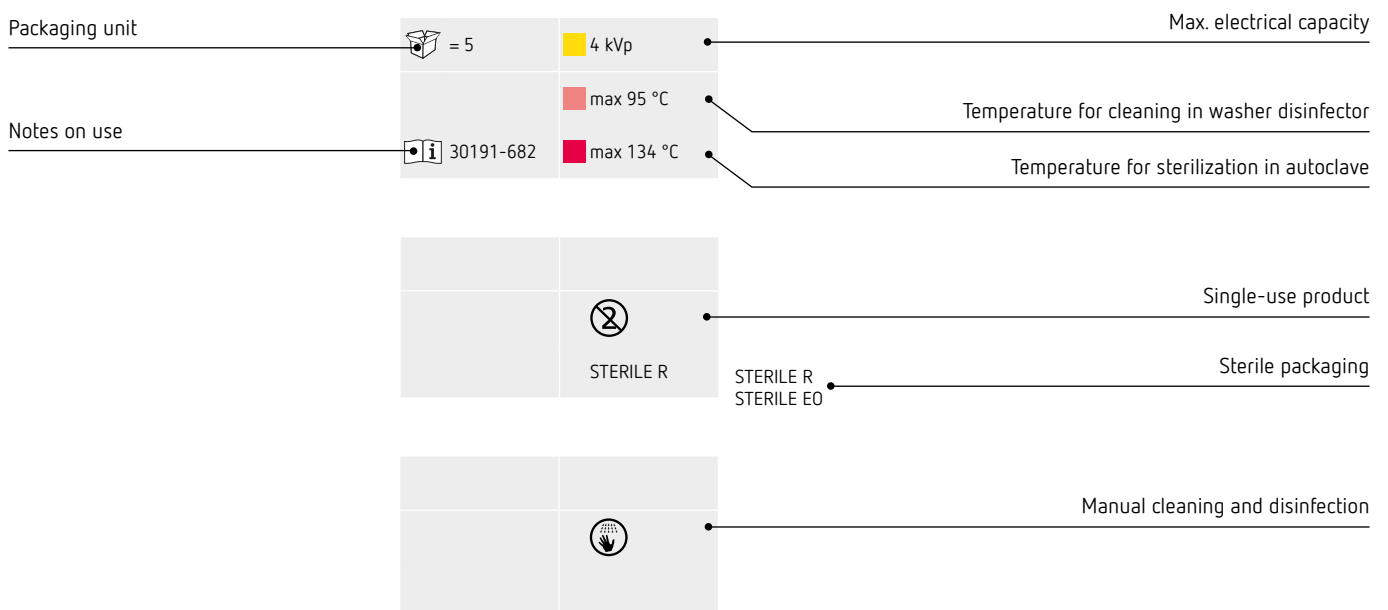











Please read carefully the corresponding notes on use before using any instrument.

Electrosurgery

Bipolar forceps

04	Bipolar forceps PREMIUM, straight	22	Bipolar forceps Classic, angled and bayonet
08	Bipolar forceps PREMIUM, bayonet	28	Bipolar forceps Classic, corrugated
14	Bipolar forceps Classic, straight	31	Bipolar irrigation forceps

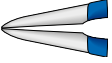
Overview

Type of forceps	Form of forceps	Type of tip	Type of clasps
<p><i>PREMIUM</i></p> <p><i>Classic</i></p> <p><i>Irrigation forceps</i></p>	<p><i>Straight</i></p>  <p><i>Bayonet</i></p>  <p><i>Angled</i></p> 	<p><i>Pointed 0.2 mm</i></p>  <p><i>Very fine 0.3 – 0.4 mm</i></p>  <p><i>Fine 0.5 – 0.7 mm</i></p>  <p><i>Blunt 1.0 – 1.2 mm</i></p>  <p><i>Blunt 2.0 – 2.2 mm</i></p> 	<p><i>Punctiform</i></p>  <p><i>Parallel</i></p> 

Bipolar forceps

Bipolar forceps PREMIUM, straight

Bipolar forceps PREMIUM, straight



No.	
= 1	0.5 kVp
	max 95 °C
30195-120	max 138 °C

100 %

Form of tip	Length	Length of tip	Form of forceps	No.
● Tip 0.2 mm, pointed 	120 mm 185 mm 200 mm	8 mm 8 mm 8 mm	straight straight straight	20195-501 20195-505 20195-510
● Tip 0.3 – 0.4 mm, very fine 	120 mm 185 mm 200 mm	8 mm 8 mm 8 mm	straight straight straight	20195-502 20195-506 20195-511
● Tip 0.5 – 0.7 mm, fine 	120 mm 120 mm 185 mm	8 mm 8 mm 8 mm	straight angled, 45° straight	20195-503 20195-504 20195-507
● Tip 1 mm, blunt 	185 mm 185 mm 200 mm 200 mm 260 mm	8 mm 8 mm 8 mm 8 mm 8 mm	straight angled, 30° straight angled, 30° angled, 30°	20195-508 20195-509 20195-512 20195-513 20195-516
● Tip 2 mm, blunt 	200 mm 230 mm 260 mm 280 mm	8 mm 8 mm 8 mm 8 mm	angled, 30° straight angled, 30° straight	20195-514 20195-515 20195-517 20195-518

Bipolar connecting cables	Length	Piece	No.
Standard 	4 m 5 m	1	20196-045 20196-057
MF plug 	4 m	1	20196-124
International (2-Pin 22 mm) 	4 m 5 m	1	20196-053 20196-061
Martin Standard 	4 m 5 m	1	20196-047 20196-059
Valleylab (2-Pin 28 mm) 	4 m	1	20196-055

Bipolar forceps

Bipolar forceps PREMIUM, straight

Bipolar forceps PREMIUM, straight, tip 0.2 mm, pointed, length 120 mm



No. 20195-501



= 1

0.5 kVp

max 95 °C



30195-120

max 138 °C

Bipolar forceps PREMIUM, straight, tip 0.4 mm, very fine, length 120 mm



No. 20195-502



= 1

0.5 kVp

max 95 °C



30195-120

max 138 °C

Bipolar forceps PREMIUM, straight, tip 0.7 mm, fine, length 120 mm



No. 20195-503



= 1

0.5 kVp

max 95 °C



30195-120

max 138 °C

Bipolar forceps PREMIUM, straight, tip 0.7 mm, fine, angled, length 120 mm



No. 20195-504



= 1

0.5 kVp

max 95 °C



30195-120

max 138 °C

Bipolar forceps PREMIUM, straight, tip 0.2 mm, pointed, length 185 mm



No. 20195-505



= 1

0.5 kVp

max 95 °C



30195-120

max 138 °C

Bipolar forceps PREMIUM, straight, tip 0.4 mm, very fine, length 185 mm



No. 20195-506



= 1

0.5 kVp

max 95 °C



30195-120

max 138 °C

Bipolar forceps

Bipolar forceps PREMIUM, straight

Bipolar forceps PREMIUM, straight, tip 0.7 mm, fine, length 185 mm



No. 20195-507



0.5 kVp

max 95 °C



30195-120

max 138 °C

Bipolar forceps PREMIUM, straight, tip 1 mm, blunt, length 185 mm



No. 20195-508



0.5 kVp

max 95 °C



30195-120

max 138 °C

Bipolar forceps PREMIUM, straight, tip 1 mm, blunt, angled, length 185 mm



No. 20195-509



0.5 kVp

max 95 °C



30195-120

max 138 °C

Bipolar forceps PREMIUM, straight, tip 0.2 mm, pointed, length 200 mm



No. 20195-510



0.5 kVp

max 95 °C



30195-120

max 138 °C

Bipolar forceps PREMIUM, straight, tip 0.4 mm, very fine, length 200 mm



No. 20195-511



0.5 kVp

max 95 °C



30195-120

max 138 °C

Bipolar forceps PREMIUM, straight, tip 1 mm, blunt, length 200 mm



No. 20195-512



0.5 kVp

max 95 °C



30195-120

max 138 °C

Bipolar forceps

Bipolar forceps PREMIUM, straight

Bipolar forceps PREMIUM, straight, tip 1 mm, blunt, angled, length 200 mm



No. 20195-513



0.5 kVp

max 95 °C



30195-120

max 138 °C

Bipolar forceps PREMIUM, straight, tip 2 mm, blunt, angled, length 200 mm



No. 20195-514



0.5 kVp

max 95 °C



30195-120

max 138 °C

Bipolar forceps PREMIUM, straight, tip 2 mm, blunt, length 230 mm



No. 20195-515



0.5 kVp

max 95 °C



30195-120

max 138 °C

Bipolar forceps PREMIUM, straight, tip 1 mm, blunt, angled, length 260 mm



No. 20195-516



0.5 kVp

max 95 °C



30195-120

max 138 °C

Bipolar forceps PREMIUM, straight, tip 2 mm, blunt, angled, length 260 mm



No. 20195-517



0.5 kVp

max 95 °C



30195-120

max 138 °C

Bipolar forceps PREMIUM, straight, tip 2 mm, blunt, length 280 mm

e.g. for urology



No. 20195-518



0.5 kVp

max 95 °C



30195-120

max 138 °C

Bipolar forceps

Bipolar forceps PREMIUM, bayonet

Bipolar forceps PREMIUM, bayonet



No.	
= 1	0.5 kVp
	max 95 °C
30195-120	max 138 °C

Form of tip	Length	Length of tip	Form of forceps	No.
Tip 0.2 mm, pointed 	155 mm	8 mm	straight	20195-531
	170 mm	8 mm	straight	20195-534
	200 mm	8 mm	straight	20195-560
	230 mm	8 mm	straight	20195-543
	250 mm	8 mm	straight	20195-551
Tip 0.3 – 0.4 mm, very fine 	155 mm	8 mm	straight	20195-532
	200 mm	8 mm	straight	20195-536
	230 mm	8 mm	straight	20195-544
	250 mm	8 mm	straight	20195-552
Tip 0.5 – 0.7 mm, fine 	155 mm	8 mm	straight	20195-533
	170 mm	8 mm	straight	20195-557
	200 mm	8 mm	straight	20195-537
	230 mm	8 mm	straight	20195-545
	230 mm	8 mm	angled upwards, 135°	20195-548
	230 mm	8 mm	angled downwards, 135°	20195-550
	250 mm	8 mm	straight	20195-553
	250 mm	8 mm	angled upwards, 135°	20195-556
Tip 1 mm, blunt 	170 mm	8 mm	straight	20195-535
	200 mm	8 mm	straight	20195-538
	230 mm	8 mm	straight	20195-546
	250 mm	8 mm	straight	20195-554
Tip 1,2 mm, blunt 	200 mm	8 mm	straight	20195-539
	200 mm	8 mm	angled downwards, 135°	20195-541
	200 mm	8 mm	angled upwards, 135°	20195-542
	230 mm	8 mm	straight	20195-547
	230 mm	8 mm	angled upwards, 135°	20195-549
Tip 2 mm, blunt 	250 mm	8 mm	straight	20195-555
	170 mm	8 mm	straight	20195-559
	200 mm	8 mm	straight	20195-540
	230 mm	8 mm	straight	20195-561
250 mm	8 mm	straight	20195-558	

Bipolar connecting cables	Length	Piece	No.
Standard	4 m	1	20196-045 20196-057
	5 m		
MF plug	4 m	1	20196-124
International (2-Pin 22 mm)	4 m	1	20196-053 20196-061
	5 m		
Martin Standard	4 m	1	20196-047 20196-059
	5 m		
Valleylab (2-Pin 28 mm)	4 m	1	20196-055

Bipolar forceps

Bipolar forceps PREMIUM, bayonet

Bipolar forceps PREMIUM, bayonet, tip 0.2 mm, pointed, length 155 mm



No. 20195-531



0.5 kVp

max 95 °C



30195-120

max 138 °C

Bipolar forceps PREMIUM, bayonet, tip 0.4 mm, very fine, length 155 mm



No. 20195-532



0.5 kVp

max 95 °C



30195-120

max 138 °C

Bipolar forceps PREMIUM, bayonet, tip 0.7 mm, fine, length 155 mm



No. 20195-533



0.5 kVp

max 95 °C



30195-120

max 138 °C

Bipolar forceps PREMIUM, bayonet, tip 0.2 mm, pointed, length 170 mm



No. 20195-534



0.5 kVp

max 95 °C



30195-120

max 138 °C

Bipolar forceps PREMIUM, bayonet, tip 0.7 mm, fine, length 170 mm



No. 20195-557



0.5 kVp

max 95 °C



30195-120

max 138 °C

Bipolar forceps PREMIUM, bayonet, tip 1 mm, blunt, length 170 mm



No. 20195-535



0.5 kVp

max 95 °C



30195-120

max 138 °C

Bipolar forceps PREMIUM, bayonet, tip 2.0 mm, blunt, length 170 mm



No. 20195-559



0.5 kVp

max 95 °C



30195-120

max 138 °C

Bipolar forceps

Bipolar forceps PREMIUM, bayonet

Bipolar forceps PREMIUM, bayonet, tip 0.2 mm, pointed, length 200 mm



No. 20195-560

= 1

0.5 kVp

max 95 °C

30195-120

max 138 °C

Bipolar forceps PREMIUM, bayonet, tip 0.4 mm, very fine, length 200 mm



No. 20195-536

= 1

0.5 kVp

max 95 °C

30195-120

max 138 °C

Bipolar forceps PREMIUM, bayonet, tip 0.7 mm, fine, length 200 mm



No. 20195-537

= 1

0.5 kVp

max 95 °C

30195-120

max 138 °C

Bipolar forceps PREMIUM, bayonet, tip 1 mm, blunt, length 200 mm



No. 20195-538

= 1

0.5 kVp

max 95 °C

30195-120

max 138 °C

Bipolar forceps PREMIUM, bayonet, tip 1.2 mm, blunt, length 200 mm



No. 20195-539

= 1

0.5 kVp

max 95 °C

30195-120

max 138 °C

Bipolar forceps PREMIUM, bayonet, tip 2 mm, blunt, length 200 mm



No. 20195-540

= 1

0.5 kVp

max 95 °C

30195-120

max 138 °C

Bipolar forceps

Bipolar forceps PREMIUM, bayonet

Bipolar forceps PREMIUM, bayonet, tip 1.2 mm, blunt, length 200 mm

angled downwards



No. 20195-541



0.5 kVp

max 95 °C



30195-120

max 138 °C

Bipolar forceps PREMIUM, bayonet, tip 1.2 mm, blunt, length 200 mm

angled upwards



No. 20195-542



0.5 kVp

max 95 °C



30195-120

max 138 °C

Bipolar forceps PREMIUM, bayonet, tip 0.2 mm, pointed, length 230 mm



No. 20195-543



0.5 kVp

max 95 °C



30195-120

max 138 °C

Bipolar forceps PREMIUM, bayonet, tip 0.4 mm, very fine, length 230 mm



No. 20195-544



0.5 kVp

max 95 °C



30195-120

max 138 °C

Bipolar forceps PREMIUM, bayonet, tip 0.7 mm, fine, length 230 mm



No. 20195-545



0.5 kVp

max 95 °C



30195-120

max 138 °C

Bipolar forceps PREMIUM, bayonet, tip 1 mm, blunt, length 230 mm



No. 20195-546



0.5 kVp

max 95 °C



30195-120

max 138 °C

Bipolar forceps

Bipolar forceps PREMIUM, bayonet

Bipolar forceps PREMIUM, bayonet, tip 1.2 mm, blunt, length 230 mm



No. 20195-547

= 1

0.5 kVp

max 95 °C

30195-120

max 138 °C

Bipolar forceps PREMIUM, bayonet, tip 2 mm, blunt, length 230 mm



No. 20195-561

= 1

0.5 kVp

max 95 °C

30195-120

max 138 °C

Bipolar forceps PREMIUM, bayonet, tip 0.7 mm, fine, length 230 mm

angled upwards



No. 20195-548

= 1

0.5 kVp

max 95 °C

30195-120

max 138 °C

Bipolar forceps PREMIUM, bayonet, tip 1.2 mm, blunt, length 230 mm

angled upwards



No. 20195-549

= 1

0.5 kVp

max 95 °C

30195-120

max 138 °C

Bipolar forceps PREMIUM, bayonet, tip 0.7 mm, fine, length 230 mm

angled downwards



No. 20195-550

= 1

0.5 kVp

max 95 °C

30195-120

max 138 °C

Bipolar forceps PREMIUM, bayonet, tip 0.2 mm, pointed, length 250 mm



No. 20195-551

= 1

0.5 kVp

max 95 °C

30195-120

max 138 °C

Bipolar forceps

Bipolar forceps PREMIUM, bayonet

Bipolar forceps PREMIUM, bayonet, tip 0.4 mm, very fine, length 250 mm



No. 20195-552



= 1

0.5 kVp

max 95 °C



30195-120

max 138 °C

Bipolar forceps PREMIUM, bayonet, tip 0.7 mm, fine, length 250 mm



No. 20195-553



= 1

0.5 kVp

max 95 °C



30195-120

max 138 °C

Bipolar forceps PREMIUM, bayonet, tip 1 mm, blunt, length 250 mm



No. 20195-554



= 1

0.5 kVp

max 95 °C



30195-120

max 138 °C

Bipolar forceps PREMIUM, bayonet, tip 1.2 mm, blunt, length 250 mm



No. 20195-555



= 1

0.5 kVp

max 95 °C



30195-120

max 138 °C

Bipolar forceps PREMIUM, bayonet, tip 0.7 mm, fine, length 250 mm

angled upwards



No. 20195-556



= 1

0.5 kVp

max 95 °C



30195-120

max 138 °C

Bipolar forceps PREMIUM, bayonet, tip 2 mm, blunt, length 250 mm



No. 20195-558



= 1

0.5 kVp

max 95 °C



30195-120

max 138 °C

Bipolar forceps

Bipolar forceps Classic, straight

Bipolar forceps Classic, straight



No.	
= 1	0.5 kVp
	max 95 °C
30195-011	max 138 °C

Form of tip	Length	Length of tip	Form of forceps	Type of clasps	No.
100 % 	105 mm	6 mm	straight	punctiform	20195-019
	105 mm	5 mm	short angled, 45°	punctiform	20195-022
	105 mm	6 mm	angled, 45°	punctiform	20195-023
	165 mm	6 mm	straight	punctiform	20195-011
	165 mm	6 mm	angled, 30°	punctiform	20195-013
	190 mm	6 mm	straight	punctiform	20195-037
	165 mm	6 mm	angled, 30°	punctiform	20195-036
	105 mm	6 mm	straight	punctiform	20195-020
	105 mm	6 mm	angled, 45°	punctiform	20195-021
	150 mm	8 mm	straight	punctiform	20195-005
	165 mm	5 mm	short angled, 45°	punctiform	20195-066
	190 mm	5 mm	short angled, 45°	punctiform	20195-065
	225 mm	5 mm	angled, 45°	punctiform	20195-064
	145 mm	10 mm	straight	punctiform	20195-038
	165 mm	6 mm	straight	punctiform	20195-010
	165 mm	10 mm	straight	punctiform	20195-039
	165 mm	6 mm	angled, 30°	punctiform	20195-014
	165 mm	6 mm	angled, 30°	punctiform	20195-493
	190 mm	10 mm	straight	punctiform	20195-040
	190 mm	8 mm	straight	parallel	20195-000
	190 mm	8 mm	angled, 30°	parallel	20195-001
	190 mm	6 mm	angled, 30°	parallel	20195-490
	225 mm	10 mm	straight	punctiform	20195-041
	145 mm	10 mm	straight	punctiform	20195-027
	165 mm	10 mm	straight	punctiform	20195-028
	190 mm	10 mm	straight	punctiform	20195-029
	190 mm	6 mm	angled, 30°	punctiform	20195-007
	190 mm	6 mm	angled, 30°	punctiform	20195-492
	225 mm	10 mm	straight	punctiform	20195-030
	260 mm	10 mm	straight	punctiform	20195-110
	300 mm	10 mm	straight	punctiform	20195-109

Bipolar connecting cables	Length	Piece	No.
Standard	4 m	1	20196-045 20196-057
	5 m		
MF plug	4 m	1	20196-124
International (2-Pin 22 mm)	4 m	1	20196-053 20196-061
	5 m		
Martin Standard	4 m	1	20196-047 20196-059
	5 m		
Valleylab (2-Pin 28 mm)	4 m	1	20196-055

Bipolar forceps

Bipolar forceps Classic, straight

Bipolar forceps Classic, straight, pointed, length 105 mm

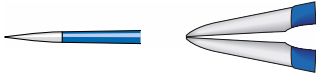

No. 20195-019

= 1

0.3 kVp

max 95 °C

30195-011

max 138 °C

Bipolar forceps Classic, straight, tip 0.5 mm, fine, length 105 mm



No. 20195-020

= 1

0.3 kVp

max 95 °C

30195-011

max 138 °C

Bipolar forceps Classic, short angled, pointed, length 105 mm



No. 20195-022

= 1

0.3 kVp

max 95 °C

30195-011

max 138 °C

Bipolar forceps Classic, angled, pointed, length 105 mm



No. 20195-023

= 1

0.3 kVp

max 95 °C

30195-011

max 138 °C

Bipolar forceps Classic, angled, tip 0.5 mm, fine, length 105 mm



No. 20195-021

= 1

0.3 kVp

max 95 °C

30195-011

max 138 °C

Bipolar forceps Classic, straight, tip 1 mm, blunt, length 145 mm

without guide bar



No. 20195-038

= 1

0.5 kVp

max 95 °C

30195-011

max 138 °C

Bipolar forceps

Bipolar forceps Classic, straight

Bipolar forceps Classic, straight, tip 2 mm, blunt, length 145 mm

without guide bar



No. 20195-027



0.5 kVp

max 95 °C



30195-011

max 138 °C

Bipolar forceps Classic, straight, tip 0.7 mm, fine, length 150 mm

without guide bar



No. 20195-005



0.5 kVp

max 95 °C



30195-011

max 138 °C

Bipolar forceps Classic, straight, pointed, length 165 mm



No. 20195-011



0.5 kVp

max 95 °C



30195-011

max 138 °C

Bipolar forceps Classic, straight, tip 1 mm, blunt, length 165 mm



No. 20195-010



0.5 kVp

max 95 °C



30195-011

max 138 °C

Bipolar forceps Classic, straight, tip 1 mm, blunt, length 165 mm

without guide bar



No. 20195-039



0.5 kVp

max 95 °C



30195-011

max 138 °C

Bipolar forceps Classic, straight, tip 2 mm, blunt, length 165 mm

without guide bar



No. 20195-028



0.5 kVp

max 95 °C



30195-011

max 138 °C

Bipolar forceps

Bipolar forceps Classic, straight

Bipolar forceps Classic, angled, pointed, length 165 mm

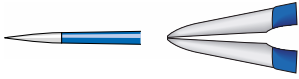

No. 20195-013	
= 1	0.5 kVp
	max 95 °C
30195-011	max 138 °C

Bipolar forceps Classic, angled, tip 0.4 mm, very fine, length 165 mm

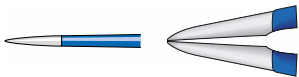

No. 20195-036	
= 1	0.5 kVp
	max 95 °C
30195-011	max 138 °C

Bipolar forceps Classic, short angled, tip 0.7 mm, fine, length 165 mm

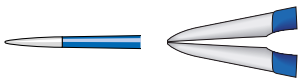

No. 20195-066	
= 1	0.5 kVp
	max 95 °C
30195-011	max 138 °C

Bipolar forceps Classic, angled, tip 1 mm, blunt, length 165 mm

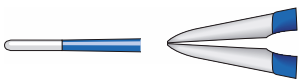

No. 20195-014	
= 1	0.5 kVp
	max 95 °C
30195-011	max 138 °C

Bipolar forceps Classic, angled, tip 1 mm, blunt, length 165 mm

without guide bar

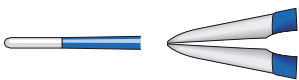

No. 20195-493	
= 1	0.5 kVp
	max 95 °C
30195-011	max 138 °C

Bipolar forceps Classic, straight, pointed, length 190 mm

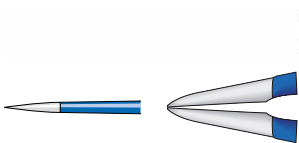

No. 20195-037	
= 1	0.5 kVp
	max 95 °C
30195-011	max 138 °C

Bipolar forceps

Bipolar forceps Classic, straight

Bipolar forceps Classic, straight, tip 1 mm, blunt, length 190 mm

without guide bar



No. 20195-040



= 1

0.5 kVp

max 95 °C



30195-011

max 138 °C

Bipolar forceps Classic, straight, tip 1 mm, blunt, length 190 mm



No. 20195-000



= 1

0.5 kVp

max 95 °C



30195-011

max 138 °C

Bipolar forceps Classic, straight, tip 2 mm, blunt, length 190 mm

without guide bar



No. 20195-029



= 1

0.5 kVp

max 95 °C



30195-011

max 138 °C

Bipolar forceps Classic, short angled, tip 0.7 mm, fine, length 190 mm



No. 20195-065



= 1

0.5 kVp

max 95 °C



30195-011

max 138 °C

Bipolar forceps Classic, angled, tip 1 mm, blunt, length 190 mm



No. 20195-001



= 1

0.5 kVp

max 95 °C



30195-011

max 138 °C

Bipolar forceps Classic, angled, tip 1 mm, blunt, length 190 mm

without guide bar



No. 20195-490



= 1

0.5 kVp

max 95 °C



30195-011

max 138 °C

Bipolar forceps

Bipolar forceps Classic, straight

Bipolar forceps Classic, angled, tip 2 mm, blunt, length 190 mm



No. 20195-007

= 1	0.5 kVp
	max 95 °C
30195-011	max 138 °C

Bipolar forceps Classic, angled, tip 2 mm, blunt, length 190 mm

without guide bar



No. 20195-492

= 1	0.5 kVp
	max 95 °C
30195-011	max 138 °C

Bipolar forceps Classic, straight, tip 1 mm, blunt, length 225 mm

without guide bar



No. 20195-041

= 1	0.5 kVp
	max 95 °C
30195-011	max 138 °C

Bipolar forceps Classic, straight, tip 2 mm, blunt, length 225 mm

without guide bar



No. 20195-030

= 1	0.5 kVp
	max 95 °C
30195-011	max 138 °C

Bipolar forceps Classic, short angled, tip 0.7 mm, fine, length 225 mm



No. 20195-064

= 1	0.5 kVp
	max 95 °C
30195-011	max 138 °C

Bipolar forceps

Bipolar forceps Classic, straight

Bipolar forceps Classic, straight, tip 2 mm, blunt, length 260 mm



No. 20195-110



= 1

0.5 kVp

max 95 °C



30195-011

max 138 °C

Bipolar forceps Classic, straight, tip 2 mm, blunt, length 300 mm



No. 20195-109



= 1

0.5 kVp

max 95 °C



30195-011

max 138 °C



Bipolar forceps

Bipolar forceps Classic, angled and bayonet

Bipolar forceps Classic, angled and bayonet



No.	
= 1	0.5 kVp
	max 95 °C
30195-011	max 138 °C

100 %

Form of tip	Length	Length of tip	Form of forceps	Type of clasps	No.
Tip 0.2 mm, pointed 	165 mm 165 mm 190 mm	6 mm 6 mm 6 mm	angled, 160° bayonet bayonet	punctiform punctiform punctiform	20195-016 20195-017 20195-008
Tip 0.4 mm, very fine 	165 mm 165 mm 230 mm 250 mm	6 mm 6 mm 6 mm 6 mm	angled, 160° bayonet bayonet bayonet	punctiform punctiform punctiform punctiform	20195-015 20195-033 20195-044 20195-042
Tip 0.7 mm, fine 	105 mm 190 mm 190 mm 230 mm 250 mm	6 mm 5 mm 5 mm 6 mm 6 mm	angled, 170° bayonet short-angled down., 45° bayonet short-angled up., 45° bayonet bayonet	punctiform punctiform punctiform punctiform punctiform	20195-035 20195-164 20195-006 20195-045 20195-043
Tip 1 mm, blunt 	165 mm 165 mm 190 mm 190 mm	6 mm 6 mm 8 mm 6 mm	bayonet bayonet bayonet bayonet	punctiform punctiform parallel punctiform	20195-018 20195-494 20195-002 20195-491
Tip 1,2 mm, blunt 	190 mm 190 mm 230 mm 230 mm 230 mm 250 mm 250 mm 250 mm	5 mm 5 mm 6 mm 5 mm 5 mm 5 mm 5 mm 6 mm	bayonet short-angled down., 45° bayonet short-angled up., 45° bayonet bayonet short-angled up., 45° bayonet short-angled down., 45° bayonet short-angled down., 45° bayonet short-angled up., 45° bayonet	punctiform punctiform punctiform punctiform punctiform punctiform punctiform punctiform	20195-009 20195-026 20195-031 20195-063 20195-167 20195-168 20195-169 20195-032
Tip 2 mm, blunt 	190 mm 190 mm	6 mm 6 mm	bayonet bayonet	punctiform punctiform	20195-034 20195-495

Bipolar connecting cables	Length	Piece	No.
Standard 	4 m 5 m	1	20196-045 20196-057
MF plug 	4 m	1	20196-124
International (2-Pin 22 mm) 	4 m 5 m	1	20196-053 20196-061
Martin Standard 	4 m 5 m	1	20196-047 20196-059
Valleylab (2-Pin 28 mm) 	4 m	1	20196-055

Bipolar forceps

Bipolar forceps Classic, angled and bayonet

Bipolar forceps Classic, bent, tip 0.5 mm, fine, length 105 mm

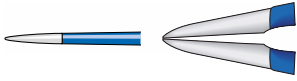

No. 20195-035



0.3 kVp

max 95 °C



30195-011

max 138 °C

Bipolar forceps Classic, bent, pointed, length 165 mm

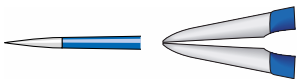

No. 20195-016



0.5 kVp

max 95 °C



30195-011

max 138 °C

Bipolar forceps Classic, bent, tip 0.4 mm, very fine, length 165 mm

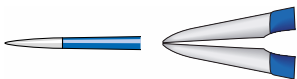

No. 20195-015



0.5 kVp

max 95 °C



30195-011

max 138 °C

Bipolar forceps Classic, bayonet, pointed, length 165 mm

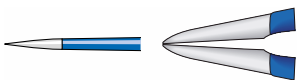

No. 20195-017



0.5 kVp

max 95 °C



30195-011

max 138 °C

Bipolar forceps Classic, bayonet, tip 0.4 mm, very fine, length 165 mm

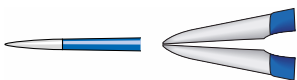

No. 20195-033



0.5 kVp

max 95 °C



30195-011

max 138 °C

Bipolar forceps Classic, bayonet, tip 1 mm, blunt, length 165 mm

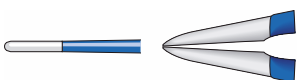

No. 20195-018



0.5 kVp

max 95 °C



30195-011

max 138 °C

Bipolar forceps

Bipolar forceps Classic, angled and bayonet

Bipolar forceps Classic, bayonet, tip 1 mm, blunt, length 165 mm

without guide bar

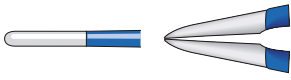

No. 20195-494



0.5 kVp

max 95 °C



30195-011

max 138 °C

Bipolar forceps Classic, bayonet, pointed, length 190 mm

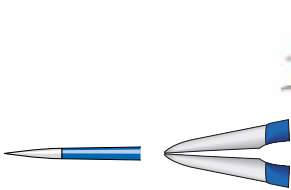

No. 20195-008



0.5 kVp

max 95 °C



30195-011

max 138 °C

Bipolar forceps Classic, bayonet, tip 1 mm, blunt, length 190 mm

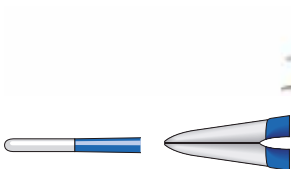

No. 20195-002



0.5 kVp

max 95 °C



30195-011

max 138 °C

Bipolar forceps Classic, bayonet, tip 1 mm, blunt, length 190 mm

without guide bar

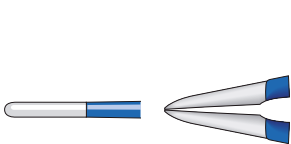

No. 20195-491



0.5 kVp

max 95 °C



30195-011

max 138 °C

Bipolar forceps Classic, bayonet, tip 2 mm, blunt, length 190 mm

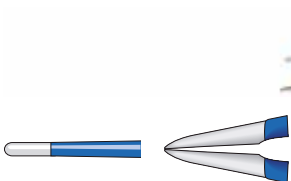

No. 20195-034



0.5 kVp

max 95 °C



30195-011

max 138 °C

Bipolar forceps Classic, bayonet, tip 2 mm, blunt, length 190 mm

without guide bar

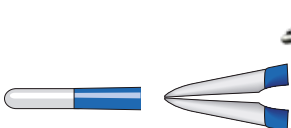

No. 20195-495



0.5 kVp

max 95 °C



30195-011

max 138 °C

Bipolar forceps

Bipolar forceps Classic, angled and bayonet

Bipolar forceps Classic, bayonet, angled downwards, tip 1.2 mm, blunt, length 190 mm



No. 20195-009



= 1

0.5 kVp

max 95 °C



30195-011

max 138 °C

Bipolar forceps Classic, bayonet, angled downwards, tip 0.7 mm, pointed, length 190 mm



No. 20195-164



= 1

0.5 kVp

max 95 °C



30195-011

max 138 °C

Bipolar forceps Classic, bayonet, short-angled upwards, tip 1.2 mm, blunt, length 190 mm



No. 20195-026



= 1

0.5 kVp

max 95 °C



30195-011

max 138 °C

Bipolar forceps Classic, bayonet, short-angled upwards, tip 0.7 mm, pointed, length 190 mm



No. 20195-006



= 1

0.5 kVp

max 95 °C



30195-011

max 138 °C

Bipolar forceps Classic, bayonet, tip 0.3 mm, very fine, length 230 mm



No. 20195-044



= 1

0.5 kVp

max 95 °C



30195-011

max 138 °C

Bipolar forceps

Bipolar forceps Classic, angled and bayonet

Bipolar forceps Classic, bayonet, tip 0.7 mm, fine, length 230 mm



No. 20195-045



= 1

0.5 kVp

max 95 °C



30195-011

max 138 °C

Bipolar forceps Classic, bayonet, tip 1.2 mm, blunt, length 230 mm



No. 20195-031



= 1

0.5 kVp

max 95 °C



30195-011

max 138 °C

Bipolar forceps Classic, bayonet, angled downwards, tip 1.2 mm, blunt, length 230 mm



No. 20195-167



= 1

0.5 kVp

max 95 °C



30195-011

max 138 °C

Bipolar forceps Classic, bayonet, short-angled upwards, tip 1.2 mm, blunt, length 230 mm



No. 20195-063



= 1

0.5 kVp

max 95 °C



30195-011

max 138 °C

Bipolar forceps Classic, bayonet, tip 0.3 mm, very fine, length 250 mm



No. 20195-042



= 1

0.5 kVp

max 95 °C



30195-011

max 138 °C

Bipolar forceps

Bipolar forceps Classic, angled and bayonet

Bipolar forceps Classic, bayonet, tip 0.7 mm, fine, length 250 mm



No. 20195-043



= 1

0.5 kVp

max 95 °C



30195-011

max 138 °C

Bipolar forceps Classic, bayonet, tip 1.2 mm, blunt, length 250 mm



No. 20195-032



= 1

0.5 kVp

max 95 °C



30195-011

max 138 °C

Bipolar forceps Classic, bayonet, angled downwards, tip 1.2 mm, blunt, length 250 mm



No. 20195-168



= 1

0.5 kVp

max 95 °C



30195-011

max 138 °C

Bipolar forceps Classic, bayonet, angled upwards, tip 1.2 mm, blunt, length 250 mm



No. 20195-169



= 1

0.5 kVp

max 95 °C



30195-011

max 138 °C

Bipolar forceps

Bipolar forceps Classic, corrugated

Bipolar forceps Classic, angled, tip 2 mm, blunt, length 180 mm

acc. to Meuser



No. 20195-101



0.5 kVp

max 95 °C



30195-011

max 134 °C

Bipolar forceps Classic, straight, tip 1.1 mm, blunt, length 190 mm

without guide bar



No. 20195-098



0.5 kVp

max 95 °C



30195-011

max 134 °C

Bipolar forceps Classic, straight, tip 2.2 mm, blunt, length 190 mm

without guide bar



No. 20195-057



0.5 kVp

max 95 °C



30195-011

max 134 °C

Bipolar forceps Classic, angled, tip 2.2 mm, blunt, length 190 mm

without guide bar



No. 20195-058



0.5 kVp

max 95 °C



30195-011

max 134 °C

Bipolar forceps Classic, bayonet, tip 2.2 mm, blunt, length 190 mm

without guide bar



No. 20195-059



0.5 kVp

max 95 °C



30195-011

max 134 °C

Bipolar forceps Classic, angled, tip 2.2 mm, blunt, length 240 mm

without guide bar



No. 20195-107



0.5 kVp

max 95 °C



30195-011

max 134 °C

Bipolar forceps

Bipolar forceps Classic, corrugated

Bipolar forceps Classic, straight, tip 2.2 mm, blunt, length 250 mm

without guide bar



No. 20195-498



= 1

0.5 kVp

max 95 °C



30195-011

max 138 °C

Bipolar forceps Classic, straight, tip 2.2 mm, blunt, length 300 mm

without guide bar



No. 20195-499



= 1

0.5 kVp

max 95 °C



30195-011

max 138 °C



Bipolar forceps

Bipolar irrigation forceps

Bipolar irrigation forceps, straight, tip 1.5 mm, blunt, length 200 mm



No. 20195-150



= 1

0.5 kVp

max 95 °C



30195-098

max 138 °C

Bipolar irrigation forceps, bayonet, tip 0.5 mm, fine, length 200 mm



No. 20195-151



= 1

0.5 kVp

max 95 °C



30195-098

max 138 °C

Bipolar irrigation forceps, bayonet, tip 1 mm, blunt, length 200 mm



No. 20195-152



= 1

0.5 kVp

max 95 °C



30195-098

max 138 °C

Bipolar irrigation forceps, bayonet, tip 0.5 mm, fine, length 230 mm



No. 20195-153



= 1

0.5 kVp

max 95 °C



30195-098

max 138 °C

Bipolar irrigation forceps, bayonet, tip 1 mm, blunt, length 230 mm



No. 20195-154



= 1

0.5 kVp

max 95 °C



30195-098

max 138 °C

Tubing set EIP 2 for irrigation forceps, without connecting cable, length 2.8 m



replaces 20325-020

No. 20325-011



= 10



D148285

STERILE EO

Important information

We have prepared this document with care. Nonetheless, we cannot completely rule out errors in this document.

The information, recommendations and other data ("Information") contained in this document reflect our state of knowledge and the state of science and technology at the time of preparing the document. The information is of a general nature, non-binding and serves solely for general information purposes and does not represent instructions for use or notes on application.

The information and recommendations contained in this document do not constitute any legal obligations by Erbe Elektromedizin GmbH as well as their associated companies ("Erbe") or any other claims against Erbe. The information does not represent a guarantee or other quality statement, these require the express contractual arrangement with Erbe in individual cases.

Erbe shall not be liable for any type of damage resulting from following information given in this document, regardless of the legal reason for liability.

Every user of an Erbe product is responsible for checking the respective Erbe product for its properties as well as the suitability for the intended type of application or intended purpose in advance. The suitable type of application of the respective Erbe product is given by the user manual and the notes on use for the corresponding Erbe product. The user is obliged to check whether the existing user manual and the notes on use correspond with the status for the specific Erbe product. The devices may only be used according to the user manual and the notes on use.

The information on setting values, application sites, duration of application and the use of the respective Erbe product is based on the clinical experience of physicians independent from Erbe. They represent guidelines which need to be checked by the user for their suitability for the actual planned application. Depending on the circumstances of an actual application case, it may be necessary to deviate from the information provided. The user has to check this on his/her own responsibility in each case when using an Erbe product. We wish to point out that science and technology is constantly subject to new developments arising from research and clinical experience. For this reason it may be necessary for the user to deviate from the information provided in this document.

This document contains information about Erbe products which may possibly not be approved in a specific country. The user of the respective Erbe product is obliged to inform him/herself whether the Erbe product he/she is using is legally approved in his/her country and/or if legal requirements or restrictions for use possibly exist and to which extent.

This document is not intended for users in the USA.

Erbe Elektromedizin GmbH
Waldhoernlestrasse 17
72072 Tuebingen
Germany

Phone +49 7071 755-0
Fax +49 7071 755-179
info@erbe-med.com
erbe-med.com



Return electrodes

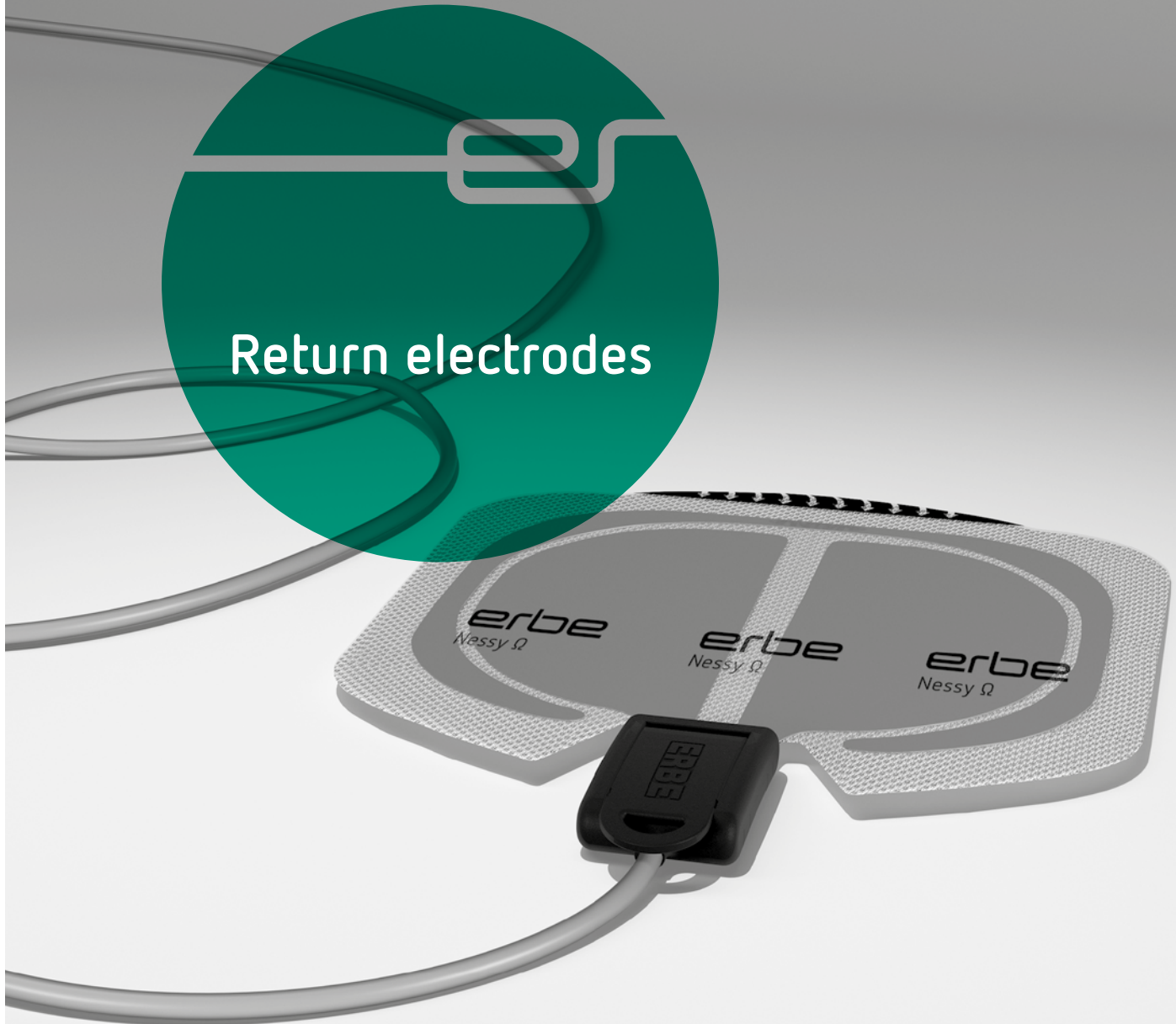

Legend

Important notes

The authors and Erbe Elektromedizin GmbH have taken the greatest possible care while compiling the catalogue with electrosurgical accessories. Nevertheless, it is impossible to exclude the possibility that errors may be contained herein.

The information and recommendations given here may not be construed as constituting any basis for any claims against Erbe Elektromedizin GmbH. Should legal regulations stipulate liability, such liability shall be limited to intentional misconduct or gross negligence.

The data on the use of instruments is based on clinical experience. Medical science is subject to a process of permanent change based on research and clinical experience. Therefore the products are subject to alterations in design and technique. Because of production tolerances dimensions in the catalogue may marginally differ.

Further product information

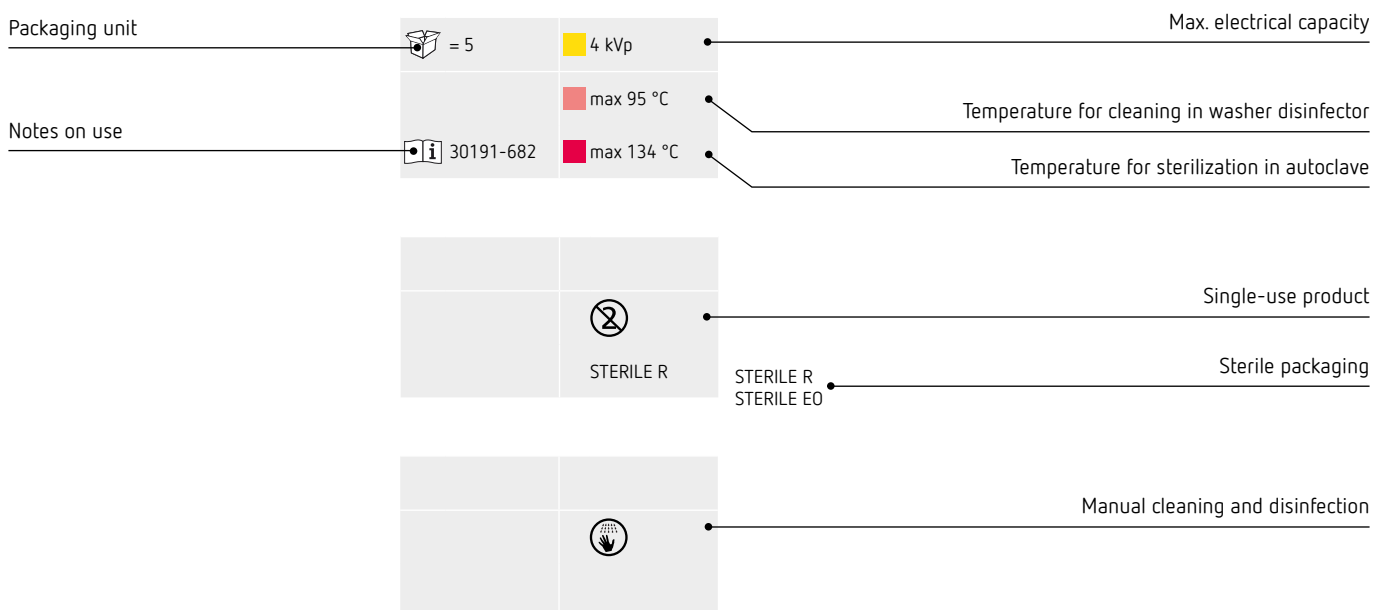

Please read carefully the corresponding notes on use before using any instrument.

Electrosurgery

Return electrodes

- 04 Single-use with contact stud
- 05 Single-use with connecting cable
- 06 Reusable with contact stud

Return electrodes

Single-use with contact stud

Erbe Nessy Ω , split, VIO, ICC, ACC, contact surface 85 cm²



equipotential ring 23 cm², without connecting cable

No. 20193-082

= 50

30193-082



Erbe NESSY Plate 170, split, VIO, ICC, ACC, contact surface 168 cm²

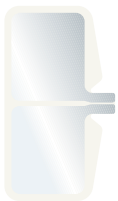

without connecting cable

No. 20193-070

= 50

30193-080



Erbe NESSY Plate 70, split, VIO, ICC, ACC, contact surface 72 cm²

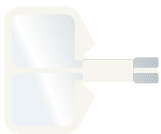

without connecting cable, for children from 5 to 15 kg

No. 20193-071

= 50

30193-080



Erbe MONOPlate 40, single, VIO, ICC, ACC, T-Series, contact surface 40 cm²

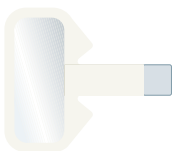

without connecting cable, for children < 5kg

No. 20193-073

= 50

30193-080



Connecting cables for return electrodes	Length	Piece	No.
Return electrode cable, VIO, ICC, ACC, T-Series, Standard, for return electrodes with contact stud	4 m 5 m	1 1	20194-077 20194-078
Return electrode cable, VIO, ICC, ACC, non-Erbe units, International, for return electrodes with split contact surface and contact stud	4 m 5 m	1 1	20194-080 20194-087
Return electrode cable, VIO, ICC, ACC, non-Erbe units, International, for return electrodes with single contact surface and contact stud	4 m 5 m	1 1	20194-079 20194-086

Return electrodes

Single use with connecting cable

Erbe NESSY Ω , split, VIO, ICC, ACC, non-Erbe units, International



contact surface 85 cm², equiptential ring 23 cm²,
with connecting cable 4 m

No. 20193-083

= 50

30193-082



Erbe NESSY Plate 170, split, VIO, ICC, ACC, non-Erbe units, International

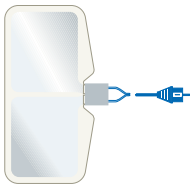

contact surface 168 cm², with connecting cable 3 m

No. 20193-074

= 50

30193-080



Erbe NESSY Plate 70, split, VIO, ICC, ACC, non-Erbe units, International

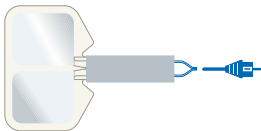

contact surface 72 cm², with connecting cable 3 m,
for children from 5 to 15 kg

No. 20193-075

= 50

30193-080



Return electrodes

Reusable with contact stud

NESSY® RePlate 200, contact surface 194 cm², reusable, can be monitored

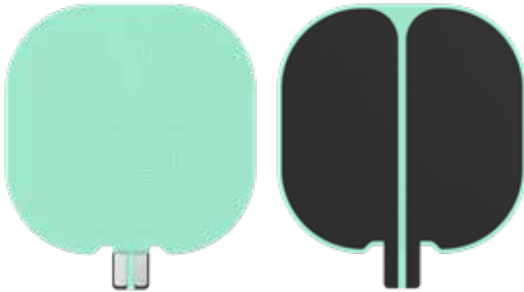

No. 20193-090

= 1

max 95 °C

30193-088

NESSY® RePlate Fixation, length 82 cm



No. 20193-091

= 1

max 95 °C

30193-088

Contact spray/Signaspray®, for NESSY® RePlate



No. 20193-092

= 1

D181820

Connecting cables for return electrodes	Length	Piece	No.
Return electrode cable, VIO, ICC, ACC, T-Series, Standard, for return electrodes with contact stud	4 m	1	20194-077 20194-078
	5 m	1	
Return electrode cable, VIO, ICC, ACC, non-Erbe units, International, for return electrodes with split contact surface and contact stud	4 m	1	20194-080 20194-087
	5 m	1	



Return electrodes

Reusable with contact stud

NESSY® RePlate kit I, reusable, incl. fixation and contact spray



No. 20193-093

= 1

max 95 °C

30193-088

NESSY® RePlate kit II, reusable, incl. fixation



No. 20193-094

= 1

max 95 °C

30193-088

Important information

We have prepared this document with care. Nonetheless, we cannot completely rule out errors in this document.

The information, recommendations and other data ("Information") contained in this document reflect our state of knowledge and the state of science and technology at the time of preparing the document. The information is of a general nature, non-binding and serves solely for general information purposes and does not represent instructions for use or notes on application.

The information and recommendations contained in this document do not constitute any legal obligations by Erbe Elektromedizin GmbH as well as their associated companies ("Erbe") or any other claims against Erbe. The information does not represent a guarantee or other quality statement, these require the express contractual arrangement with Erbe in individual cases.

Erbe shall not be liable for any type of damage resulting from following information given in this document, regardless of the legal reason for liability.

Every user of an Erbe product is responsible for checking the respective Erbe product for its properties as well as the suitability for the intended type of application or intended purpose in advance. The suitable type of application of the respective Erbe product is given by the user manual and the notes on use for the corresponding Erbe product. The user is obliged to check whether the existing user manual and the notes on use correspond with the status for the specific Erbe product. The devices may only be used according to the user manual and the notes on use.

The information on setting values, application sites, duration of application and the use of the respective Erbe product is based on the clinical experience of physicians independent from Erbe. They represent guidelines which need to be checked by the user for their suitability for the actual planned application. Depending on the circumstances of an actual application case, it may be necessary to deviate from the information provided. The user has to check this on his/her own responsibility in each case when using an Erbe product. We wish to point out that science and technology is constantly subject to new developments arising from research and clinical experience. For this reason it may be necessary for the user to deviate from the information provided in this document.

This document contains information about Erbe products which may possibly not be approved in a specific country. The user of the respective Erbe product is obliged to inform him/herself whether the Erbe product he/she is using is legally approved in his/her country and/or if legal requirements or restrictions for use possibly exist and to which extent.

This document is not intended for users in the USA.

Erbe Elektromedizin GmbH
Waldhoernlestrasse 17
72072 Tuebingen
Germany

Phone +49 7071 755-0
info@erbe-med.com
erbe-med.com
medical-videos.com



Connecting cables
and adapters

Important notes

The authors and Erbe Elektromedizin GmbH have taken the greatest possible care while compiling the catalogue with electrosurgical accessories. Nevertheless, it is impossible to exclude the possibility that errors may be contained herein.

The information and recommendations given here may not be construed as constituting any basis for any claims against Erbe Elektromedizin GmbH. Should legal regulations stipulate liability, such liability shall be limited to intentional misconduct or gross negligence.

The data on the use of instruments is based on clinical experience. Medical science is subject to a process of permanent change based on research and clinical experience. Therefore the products are subject to alterations in design and technique. Because of production tolerances dimensions in the catalogue may marginally differ.

We confirm that none of our products contain latex, except the rubber straps, Art. No. 20592-009 and 20592-011.

Further product information

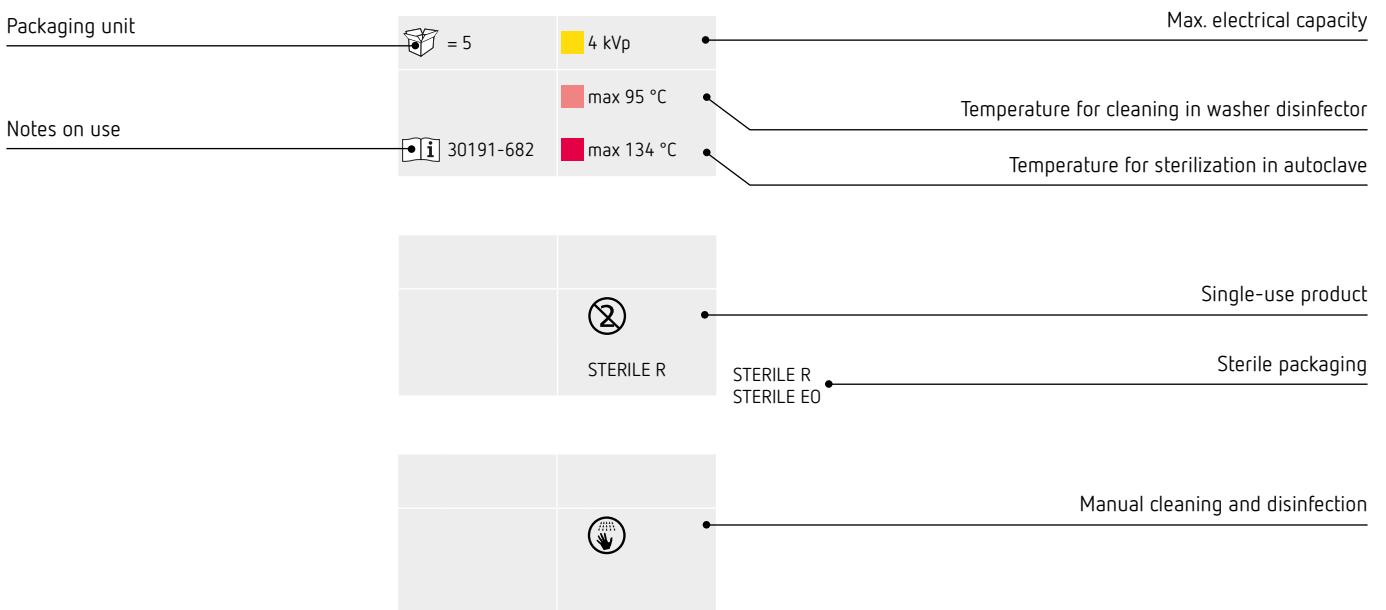

Please read carefully the corresponding notes on use before using any instrument.

Electrosurgery









Connecting cables

- 04 Monopolar connecting cables
- 08 Bipolar connecting cables
- 13 Connecting cables for return electrodes

Adapters

- 15 Monopolar adapters
- 16 Bipolar adapters
- 18 Ignition test adapters
- 18 Adapters for special purpose
- 19 Foot switch adapters
- 19 Irrigation adapters

Overview

Type of connecting cable	Cable length	Connecting plug	Adapter	Electrosurgical unit
<p>Monopolar (MO)</p> 	<p>4 m</p> <p>4.5 m</p> <p>5 m</p>	<p>Standard</p> 	<p>Monopolar</p> 	
<p>Bipolar (BI)</p> 		<p>International</p> 	<p>Bipolar</p> 	
<p>Return electrode (NE)</p> 			<p>Return electrode</p> 	

Connecting cables

Monopolar connecting cables

Monopolar connecting cable, VIO, ICC, ACC, Standard, 4 m

for electrosurgical pencil 20190-045, 20190-082 and monopolar hook electrode (MIC) 20191-179



No. 20192-127



5 kVp

max 95 °C



30192-126

max 138 °C

Monopolar connecting cable, VIO, ICC, ACC, Standard, 5 m

for electrosurgical pencil 20190-045, 20190-082 and monopolar hook electrode (MIC) 20191-179



No. 20192-094



5 kVp

max 95 °C



30192-126

max 138 °C

Monopolar connecting cable, VIO, ICC, ACC, Standard, 4 m

for suction coagulation electrode 20191-136, with internal 4 mm Pin



No. 20192-097



5 kVp

max 95 °C



30192-126

max 138 °C

Monopolar connecting cable, VIO, ICC, ACC, Standard, 4 m

for needle electrode 20191-152 with connection \varnothing 4 mm and STORZ MIS instruments, e.g. monopolar scissors



No. 20192-101



5 kVp

max 95 °C



30192-126

max 138 °C

Monopolar connecting cable, VIO, ICC, ACC, Standard, 4 m

for CUT and COAG MIS instruments, with connection \varnothing 4 mm



No. 20192-104



5 kVp

max 95 °C



30192-126

max 138 °C

Monopolar connecting cable, VIO, ICC, ACC, Standard, 4 m

e.g. for OLYMPUS polypectomy snares, with connection \varnothing 3 mm



No. 20192-119



5 kVp

max 95 °C



30192-126

max 138 °C

Connecting cables

Monopolar connecting cables

Monopolar connecting cable, VIO, ICC, ACC, International \varnothing 8 mm (Bovie Jack), 4 m

for CUT and COAG MIS instruments, with connection \varnothing 4 mm



No. 20192-113



= 1

5 kVp

max 95 °C



30192-126

max 138 °C

Monopolar connecting cable, VIO, ICC, ACC, International \varnothing 8 mm (Bovie Jack), 4 m

for OLYMPUS polypectomy snares, with connection \varnothing 3 mm



No. 20192-117



= 1

5 kVp

max 95 °C



30192-126

max 138 °C

Monopolar connecting cable, 3-Pin, \varnothing 4 mm socket, length 4.5 m

for OLYMPUS COAG MIS instruments, with connection \varnothing 4 mm



No. 20192-133



= 1

5 kVp

max 95 °C



30192-126

max 138 °C

Monopolar connecting cable, 3-Pin, \varnothing 4 mm Pin, length 4.5 m

e.g. for AutoSuture instruments, MTW snares, with connecting plug \varnothing 4 mm



No. 20192-134



= 1

5 kVp

max 95 °C



30192-126

max 138 °C

Monopolar connecting cable, 3-Pin, \varnothing 4 mm socket, length 4.5 m

for needle electrode 20191-152 with connection \varnothing 4 mm and STORZ MIS instruments, e.g. monopolar scissors



No. 20192-132



= 1

5 kVp

max 95 °C



30192-126

max 138 °C

Monopolar connecting cable, 3-Pin, \varnothing 3 mm socket, length 4.5 m

e.g. for OLYMPUS polypectomy snares, with connection \varnothing 3 mm



No. 20192-135



= 1

5 kVp

max 95 °C



30192-126

max 138 °C

Connecting cables

Monopolar connecting cables

Monopolar connecting cable, VIO, ICC, ACC, International, 4 m

for electrosurgical pencil 20190-045, 20190-082 and monopolar hook electrode (MIC) 20191-179



No. 20192-110



= 1

5 kVp

max 95 °C



30192-126

max 138 °C

Monopolar connecting cable, Martin Standard, 4 m

for electrosurgical pencil 20190-045, 20190-082 and monopolar hook electrode (MIC) 20191-179



No. 20192-099



= 1

5 kVp

max 95 °C



30192-126

max 138 °C



Connecting cables

Bipolar connecting cables

Bipolar connecting cable, VIO, ICC, ACC, T-Series, Standard, 4 m

for bipolar forceps with european flat plug



No. 20196-045



= 1

1 kVp

max 95 °C



30192-126

max 138 °C

Bipolar connecting cable, VIO, ICC, ACC, T-Series, Standard, 5 m

for bipolar forceps with european flat plug



No. 20196-057



= 1

1 kVp

max 95 °C



30192-126

max 138 °C

Bipolar connecting cable, VIO, ICC, ACC, T-Series, Standard, 4 m

for bipolar forceps with 2-Pin connection



No. 20196-121



= 1

1 kVp

max 95 °C



30192-126

max 138 °C

Bipolar connecting cable, VIO, ICC, ACC, T-Series, Standard, 4 m

for bipolar fixation forceps 20195-080, 20195-081, 20195-086, 20195-092, 20195-093 and bipolar STORZ fixation forceps



No. 20196-048



= 1

1 kVp

max 95 °C



30192-126

max 138 °C

Bipolar connecting cable, VIO, ICC, ACC, T-Series, Standard, 5 m

for bipolar fixation forceps 20195-080, 20195-081, 20195-086, 20195-092, 20195-093 and bipolar STORZ fixation forceps



No. 20196-060



= 1

1 kVp

max 95 °C



30192-126

max 138 °C

Bipolar connecting cable, VIO, ICC, ACC, T-Series, Standard, 4 m

for bipolar scissors BiSect



No. 20196-106



= 1

1 kVp

max 95 °C



30192-126

max 138 °C

Connecting cables

Bipolar connecting cables

Bipolar cable for da Vinci, Standard, 4 m



No. 20196-130



= 1

1 kVp

max 95 °C



30196-043

max 138 °C

Bipolar connecting cable, 8/4 mm, forceps, angled plug, length 4.5 m

for bipolar forceps with european flat plug



No. 20196-062



= 1

1 kVp

max 95 °C



30192-126

max 138 °C

Bipolar connecting cable, 8/4 mm, Aesculap forceps, angled plug, length 4.5 m

for bipolar Aesculap forceps



No. 20196-065



= 1

1 kVp

max 95 °C



30192-126

max 138 °C

Bipolar connecting cable, VIO, ICC, ACC, International (2-Pin 22 mm), 4 m

for bipolar forceps with european flat plug



No. 20196-053



= 1

1 kVp

max 95 °C



30192-126

max 138 °C

Bipolar connecting cable, VIO, ICC, ACC, International (2-Pin 22 mm), 5 m

for bipolar forceps with european flat plug



No. 20196-061



= 1

1 kVp

max 95 °C



30192-126

max 138 °C

Bipolar connecting cable, 2-Pin 22 mm, forceps, angled plug, length 4.5 m

for bipolar forceps with european flat plug



No. 20196-063



= 1

1 kVp

max 95 °C



30192-126

max 138 °C

Connecting cables

Bipolar connecting cables

Bipolar connecting cable, VIO, ICC, ACC, International (2-Pin 22 mm), 4 m

for bipolar scissors BiSect



No. 20196-107



= 1

1 kVp

max 95 °C



30192-126

max 138 °C

Bipolar connecting cable, 2-Pin 28 mm, forceps, angled plug, length 4.5 m

for bipolar forceps with european flat plug



No. 20196-064



= 1

1 kVp

max 95 °C



30192-126

max 138 °C

Bipolar connecting cable, Valleylab and non-Erbe units (2-Pin 28 mm), 4 m

for bipolar forceps with european flat plug



No. 20196-055



= 1

1 kVp

max 95 °C



30192-126

max 138 °C

Bipolar connecting cable, Valleylab and non-Erbe units (2-Pin 28 mm), 4 m

for bipolar forceps with 2-Pin connection



No. 20196-127



= 1

1 kVp

max 95 °C



30192-126

max 138 °C

Bipolar connecting cable for da Vinci, Valleylab and non-Erbe units (2-Pin 28 mm), 4 m

for bipolar forceps with 2-Pin connection



No. 20196-129



= 1

1 kVp

max 95 °C



30196-043

max 138 °C

Bipolar connecting cable, 2-Pin 28 mm, fixation forceps, length 4.5 m

for bipolar fixation forceps 20195-080, 20195-081, 20195-086, 20195-092, 20195-093 and bipolar STORZ fixation forceps



No. 20196-067



= 1

1 kVp

max 95 °C



30192-126

max 138 °C

Connecting cables

Bipolar connecting cables

Bipolar connecting cable, 2-Pin 28 mm, Aesculap forceps, angled plug, length 4.5 m

for bipolar Aesculap forceps



No. 20196-066



= 1

1 kVp

max 95 °C



30192-126

max 138 °C

Bipolar connecting cable, Martin Standard, 4 m

for bipolar forceps with european flat plug



No. 20196-047



= 1

1 kVp

max 95 °C



30192-126

max 138 °C

Bipolar connecting cable, Martin Standard, 5 m

for bipolar forceps with european flat plug



No. 20196-059



= 1

1 kVp

max 95 °C



30192-126

max 138 °C

Bipolar connecting cable, with MF plug, 4 m

for bipolar forceps with european flat plug



No. 20196-124



= 1

1 kVp

max 95 °C



30196-040

max 138 °C

Bipolar connecting cable, for OLYMPUS resectoscopes, with MF plug, 4 m

for VIO 3 and VIO 300 D from version V.1.6.2 on



No. 20196-115



= 1

1 kVp

max 95 °C



30196-040

max 134 °C

Bipolar connecting cable, for STORZ resectoscopes, with MF plug, 4 m

for VIO 3 and VIO 300 D from version V.1.6.2 on



No. 20196-118



= 1

1 kVp

max 95 °C



30196-040

max 134 °C

Connecting cables

Bipolar connecting cables

Bipolar connecting cable, for WOLF resectoscopes, with MF plug, 4 m

for VIO 3 and VIO 300 D from version V.1.6.2 on



No. 20196-119



= 1

1 kVp

max 95 °C



30196-040

max 134 °C

Bipolar connecting cable, for STORZ resectoscopes, with MF-U plug, 4.5 m

only for VIO 3



No. 21196-118



= 1

1 kVp

max 95 °C



30196-044

max 138 °C

Bipolar connecting cable, for WOLF resectoscopes, with MF-U plug, 4.5 m

only for VIO 3



No. 21196-119



= 1

1 kVp

max 95 °C



30196-044

max 138 °C

Bipolar connecting cable, for OLYMPUS resectoscopes, with MF-U plug, 4.5 m

only for VIO 3



No. 21196-115



= 1

1 kVp

max 95 °C



30196-044

max 138 °C

Return electrode cable, VIO, ICC, ACC, T-Series, Standard, 4 m

for return electrodes with contact stud



No. 20194-077



= 1

0.5 kVp

max 95 °C



30192-126

max 138 °C

Return electrode cable, VIO, ICC, ACC, T-Series, Standard, 5 m

for return electrodes with contact stud



No. 20194-078



= 1

0.5 kVp

max 95 °C



30192-126

max 138 °C

Connecting cables

Connecting cables for return electrodes

Return electrode cable, VIO, ICC, ACC, T-Series, Standard, 4 m

for silicone electrodes



No. 20194-070



= 1

0.5 kVp

max 95 °C



30192-126

max 138 °C

Return electrode cable, VIO, ICC, ACC, T-Series, Standard, 5 m

for silicone electrodes



No. 20194-088



= 1

0.5 kVp

max 95 °C



30192-126

max 138 °C

Return electrode cable, VIO, ICC, ACC, International, 4 m

for silicone electrodes



No. 20194-075



= 1

0.5 kVp

max 95 °C



30192-126

max 138 °C

Return electrode cable, VIO, ICC, ACC, International, 5 m

for silicone electrodes



No. 20194-089



= 1

0.5 kVp

max 95 °C



30192-126

max 138 °C

Return electrode cable, VIO, ICC, ACC, non-Erbe units, International, 4 m

for return electrodes with contact stud



No. 20194-079



= 1

0.5 kVp

max 95 °C



30192-126

max 138 °C

Return electrode cable, VIO, ICC, ACC, non-Erbe units, International, 5 m

for return electrodes with contact stud



No. 20194-086



= 1

0.5 kVp

max 95 °C



30192-126

max 138 °C

Connecting cables

Connecting cables for return electrodes

Return electrode cable, VIO, ICC, ACC, non-Erbe units, International, 4 m

for return electrodes with contact stud



No. 20194-080



= 1

0.5 kVp

max 95 °C



30192-126

max 138 °C

Return electrode cable, VIO, ICC, ACC, non-Erbe units, International, 5 m

for return electrodes with contact stud



No. 20194-087



= 1

0.5 kVp

max 95 °C



30192-126

max 138 °C

Adapters

Monopolar adapters

Monopolar adapter, VIO, ICC, ACC, Standard (MO 9/5 mm)



for connecting plug international (3 Pin)

No. 20183-028

= 1

4 kVp

30183-128



Monopolar adapter, VIO, ICC, ACC, Standard (MO 9/5 mm)



for standard Martin accessories (MO 8/4 mm)

No. 20183-047

= 1

4 kVp

30183-128



Monopolar adapter, units International \varnothing 8 mm (Bovie Jack)



for connecting plug \varnothing 2-7 mm (single-pole)

No. 20183-067

= 1

4 kVp

30183-145



Adapters

Bipolar adapters

Bipolar adapter, VIO, ICC, ACC, Standard (BI 8/4 mm)



for Martin, Berchtold, Aesculap connecting plug, Standard (BI 9/2.5 mm)

No. 20183-025

= 1

0.8 kVp

30183-128



Bipolar adapter, Erbe units, International (2-Pin 22 mm)



for standard connecting plug (BI 8/4 mm)

No. 20183-053

= 1

0.8 kVp

30183-128



Bipolar adapter, Valleylab units (2-Pin 28 mm)



for standard connecting plug (BI 8/4 mm)

No. 20183-055

= 1

0.5 kVp

30183-128



Bipolar adapter, VIO, ICC, ACC, T-Series, Standard (BI 8/4 mm)

for connecting plug international (2 x 4 mm socket), length 30 cm



No. 20183-066

= 1

1 kVp

max 95 °C

30183-153

max 138 °C

Adapters

Bipolar adapters

Adapter, MF-socket, MF-2-plug

for VIO 300 D



No. 20183-100



4.3 kVp

30183-173



Adapter, MF-2- /MF-U-socket, MF-plug

for VIO 3 and VIO 300 D



No. 20183-101



4.3 kVp

30183-173



Fastening set

Fastening set for adapter 20183-100 and 20183-101, for VIO 300 D

No.

20183-102



Fastening set for adapter 20183-101, for VIO 3

20183-103



Adapters

Ignition test adapters

APC ignition test adapter for VIO D/S, ICC, Standard (NE 6 mm)



APC ignition test adapters are not compatible with VIO 3/APC 3

No. 20183-070

= 1

max 95 °C

30183-126

max 134 °C

APC ignition test adapter for VIO D/S, ICC, International (NE 2-Pin)



APC ignition test adapters are not compatible with VIO 3/APC 3

No. 20183-071

= 1

max 95 °C

30183-126

max 138 °C

Adapter for special purpose

Adapter Bipolar Resection



Only for VIO 300 D with MF socket from version 2.2.1 or 1.8.0

No. 20183-110

= 1

30183-168



Adapters

Foot switch adapters and connecting cables

Foot switch adapter from VIO D/S to ICC two-pedal foot switch (4 poles), length 0.7 m

for OR-System e.g. DaVinci



No. 20140-004

= 1

30140-212



Foot switch adapter from VIO D/S to ICC one-pedal foot switch (7 poles), length 0.7 m

for OR-System e.g. DaVinci



No. 20140-007

= 1

30140-212



Connecting cable from ICC, ACC (4 poles) to APC 300, length 0.35 m

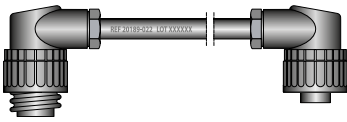

No. 20189-022

= 1

Irrigation adapters

Irrigation adapter for flexible APC probes with Luer-Lock



for APC probes with APC connecting cable 20132-158

No. 20132-203

= 5

max 95 °C

30132-209

max 138 °C

Irrigation adapter for flexible APC probes with Luer-Lock



for APC applicators with APC connecting cables 20132-046

No. 20132-095

= 5

max 95 °C

30132-209

max 138 °C

Irrigation for adapter APC applicators with Luer-Lock



for APC applicators with APC handles

No. 20132-087

= 5

max 95 °C

30132-209

max 138 °C

Important information

We have prepared this document with care. Nonetheless, we cannot completely rule out errors in this document.

The information, recommendations and other data ("Information") contained in this document reflect our state of knowledge and the state of science and technology at the time of preparing the document. The information is of a general nature, non-binding and serves solely for general information purposes and does not represent instructions for use or notes on application.

The information and recommendations contained in this document do not constitute any legal obligations by Erbe Elektromedizin GmbH as well as their associated companies ("Erbe") or any other claims against Erbe. The information does not represent a guarantee or other quality statement, these require the express contractual arrangement with Erbe in individual cases.

Erbe shall not be liable for any type of damage resulting from following information given in this document, regardless of the legal reason for liability.

Every user of an Erbe product is responsible for checking the respective Erbe product for its properties as well as the suitability for the intended type of application or intended purpose in advance. The suitable type of application of the respective Erbe product is given by the user manual and the notes on use for the corresponding Erbe product. The user is obliged to check whether the existing user manual and the notes on use correspond with the status for the specific Erbe product. The devices may only be used according to the user manual and the notes on use.

The information on setting values, application sites, duration of application and the use of the respective Erbe product is based on the clinical experience of physicians independent from Erbe. They represent guidelines which need to be checked by the user for their suitability for the actual planned application. Depending on the circumstances of an actual application case, it may be necessary to deviate from the information provided. The user has to check this on his/her own responsibility in each case when using an Erbe product. We wish to point out that science and technology is constantly subject to new developments arising from research and clinical experience. For this reason it may be necessary for the user to deviate from the information provided in this document.

This document contains information about Erbe products which may possibly not be approved in a specific country. The user of the respective Erbe product is obliged to inform him/herself whether the Erbe product he/she is using is legally approved in his/her country and/or if legal requirements or restrictions for use possibly exist and to which extent.

This document is not intended for users in the USA.

Erbe Elektromedizin GmbH
Waldhoernlestrasse 17
72072 Tuebingen
Germany

Phone +49 7071 755-0
info@erbe-med.com
erbe-med.com
medical-videos.com



Accessories for units
and modules



Legend

Important notes

The authors and Erbe Elektromedizin GmbH have taken the greatest possible care while compiling the catalogue with electrosurgical accessories. Nevertheless, it is impossible to exclude the possibility that errors may be contained herein.

The information and recommendations given here may not be construed as constituting any basis for any claims against Erbe Elektromedizin GmbH. Should legal regulations stipulate liability, such liability shall be limited to intentional misconduct or gross negligence.

The data on the use of instruments is based on clinical experience. Medical science is subject to a process of permanent change based on research and clinical experience. Therefore the products are subject to alterations in design and technique. Because of production tolerances dimensions in the catalogue may marginally differ.

Further product information

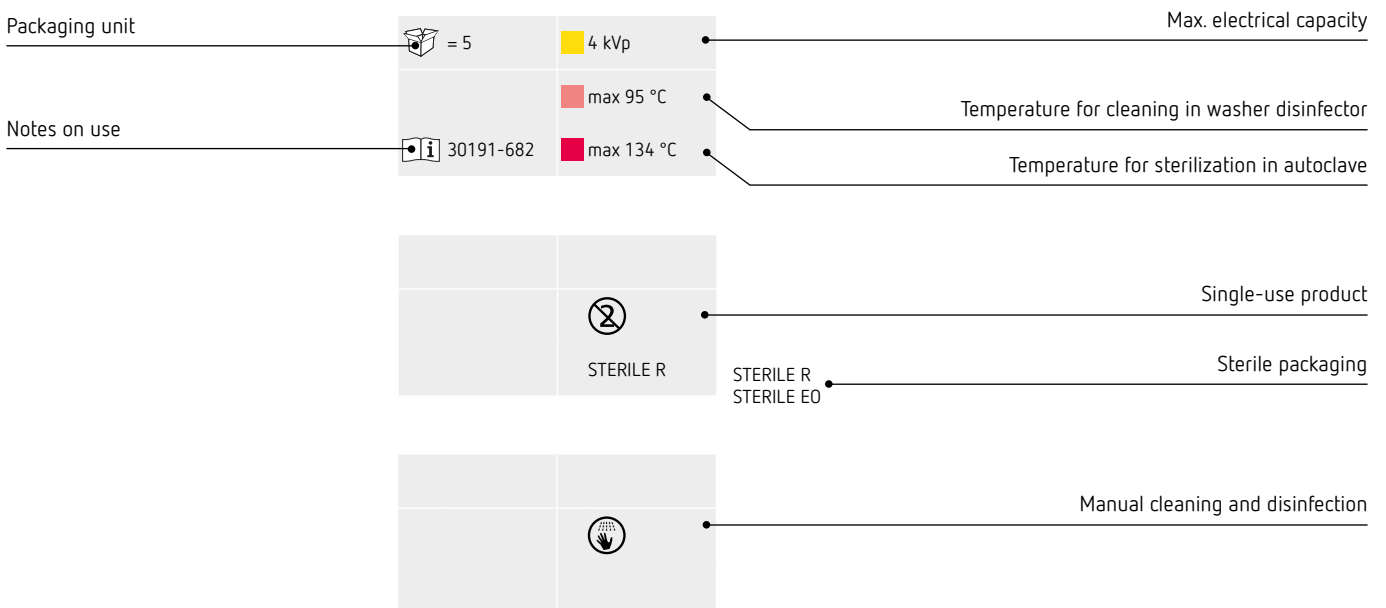

Please read carefully the corresponding notes on use before using any instrument.

Electrosurgery

Accessories for ESU

- 04 Carts and accessories
- 06 Fastening sets
- 06 Potential equalization lines / Power cords
- 07 Foot switches
- 12 Upgrades
- 12 Socket modules

Accessories for modules

- 13 APC pressure reducers and argon gas cylinders
- 16 Further APC accessories
- 17 IES smoke evacuation system
- 22 EIP 2 irrigation pump
- 24 Fluid management system
- 27 Nerve test / NT 2
- 27 Test box

Overview

Modules



ESU



Workstation



Accessories for units

Carts and accessories

VIO CART, system carrier for VIO family and modules



dimensions: 630 x 940 x 650 mm (WxHxD)
 weight: 31 kg,
 4 conductive castors \varnothing 100 mm, with fixing brake
 1 power input
 3 power outlets

incl. following accessories:
 1 grab handle out of stainless steel
 2 cable holders
 1 foot switch bracket (for currently available foot switches)

No. 20180-000

= 1

80180-018



Wire basket, 339 x 100/155 x 205 mm (W x H x D)



No. 20180-010

= 1



Cable holder



No. 20180-020

= 1



Upper bracket for VIO CART, length 260 mm



No. 20180-040

= 1



Lower bracket for VIO CART, length 390 mm

for use with secretion suction

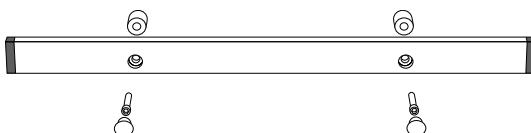

No. 20180-042

= 1



Foot switch support, plastic



for currently available VIO foot switches

No. 20180-051

= 1



Accessories for units

Carts and accessories

Cylinder pad for argon gas cylinder



No. 20180-080

= 1

Fastening strap for argon gas cylinder



No. 20180-120

= 1

Universal CART (CE) for VIO D/S, APC 2, VEM 2, EIP 2



dimensions: 520 x 890 x 465 mm (WxHxD)
 weight: 30 kg
 4 castors \varnothing 100 mm, of which front 2 conductive with fixing brake
 1 power input
 3 power outlets

incl. following accessories:
 1 instrument tray 339 x 155 x 205 mm (W x H x D)
 1 grab handle
 2 cable holders
 1 foot switch support 20180-051 for currently available foot switches
 2 cylinder pads for argon gas cylinder
 2 fastening straps for argon gas cylinder

No. 20185-205

= 1



BASIC CART with 1 drawer for VIO D/S, NT 2, VEM 2



dimensions: 510 x 790 x 560 mm (WxHxD)
 weight: 22 kg
 4 conductive castors \varnothing 100 mm, of which two with fixing brake

No. 20185-101

= 1



BASIC CART without drawer for VIO D/S, NT 2, VEM 2



dimensions: 510 x 790 x 560 mm (WxHxD)
 weight: 22 kg
 4 conductive castors \varnothing 100 mm, of which two with fixing brake

No. 20185-100

= 1



Accessories for units

Fastening sets

Fastening sets	No.
VIO 3 to VIO CART 20180-000	20180-140
APC 3 to VIO CART 20180-000	20180-141
VIO 3 and APC 3 to Konsole	20180-143
VIO 3 and APC 3 to ERBEJET 2 10150-000	20180-144
IES 3 to VIO 3	20323-007
VIO C on IES 3	20323-008
VIO D/S / APC 2 / VEM 2 on VIO CART 20180-000	20180-131
VIO D/S / APC 2 / VEM 2 on Universal CART 20185-205	20180-131
VIO D/S / APC 2 / VEM 2 on BASIC CART 20185-100, 20185-101	20180-131
VIO D/S / APC 2 / VEM 2 on console	20180-133
VIO D/S on APC 2 / VEM 2 (version since 2005)	20180-134
EIP 2 on VIO CART 20180-000	20180-135
EIP 2 on Universal CART 20185-205	20185-203
IES 2 on VIO CART 20180-000, incl. ECB cable 15 cm	20180-132

Potential equalization lines / Power cords

Potential equalization lines	Length	No.
Potential equalization line, for all types of units, connections acc. to DIN 42801	5 m	20194-025

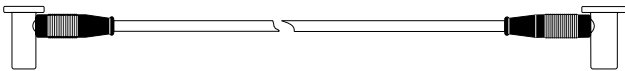

Power cords	Country	Length	No.
Power cord 10A	Germany	0.5 m	52704-046
Power cord 10A	Germany	2.5 m	52704-037
Power cord 10A	Germany	4 m	52704-032
Power cord 10A	Germany	5 m	52704-042
Power cord 10A	Great Britain	2.5 m	52704-038
Power cord 10A	Great Britain	5 m	52704-043
Power cord 10A	Italy	2.5 m	52704-040
Power cord 10A	Italy	5 m	52704-045
Power cord 10A	Canada	4 m	52704-039

Accessories for units

Foot switches

ReMode two-pedal footswitch with bracket and center bar for VIO 3, AP & IP X8 Equipment



with connecting cable 5 m

No. 20189-353

= 1

max 75 °C

30189-306



ReMode two-pedal foot switch with bracket for VIO 3, AP & IP X8 Equipment



with connecting cable 5 m

No. 20189-351

= 1

max 75 °C

30189-306



ReMode two-pedal foot switch with center bar for VIO 3, AP & IP X8 Equipment



with connecting cable 5 m

No. 20189-352

= 1

max 75 °C

30189-306



ReMode two-pedal foot switch for VIO 3, AP & IP X8 Equipment



with connecting cable 5 m

No. 20189-350

= 1

max 75 °C

30189-306



ReMode one-pedal foot switch for VIO 3, AP & IP X8 Equipment



with connecting cable 5 m

No. 20188-350

= 1

max 75 °C

30189-306



Accessories for units

Foot switches

ReMode two-pedal foot switch for VIO D with bracket, AP & IP X8 equipment



with connecting cable 5 m, ReMode function only available with VIO D

No. 20189-301

= 1

max 75 °C

30189-301



ReMode two-pedal foot switch for VIO D, AP & IP X8 equipment



with connecting cable 5 m, ReMode function only available with VIO D

No. 20189-303

= 1

max 75 °C

30189-301



Two-pedal foot switch for VIO D/S with bracket, AP & IP X8 equipment



with connecting cable 5 m

No. 20189-300

= 1

max 75 °C

30189-301



Two-pedal foot switch for VIO D/S, AP & IP X8 equipment



with connecting cable 5 m

No. 20189-302

= 1

max 75 °C

30189-301



ReMode one-pedal foot switch for VIO D, AP & IP X8 equipment



with connecting cable 5 m, for VIO D from version V 1.7.6

No. 20188-302

= 1

max 75 °C

30189-301



Accessories for units

Foot switches

One-pedal foot switch for VIO D/S, AP & IP X8 equipment



with connecting cable 5 m

No. 20188-300

= 1

max 75 °C

30189-301



Two-pedal foot switch for VIO C, AP & IP X8 equipment



with connecting cable 5 m

No. 20189-107

= 1

30189-108



One-pedal foot switch for VIO C, AP & IP X8 equipment



with connecting cable 5 m

No. 20188-102

= 1

30189-108



Further accessories for VIO foot switch	No.
Hoop guard for VIO two-pedal foot switch	20189-306
Middle piece for two-pedal foot switch	20189-308
Cable for VIO 3 foot switch, length 5 m	20189-355
Cable for VIO foot switch, length 5 m	20189-309
Extension cable for VIO foot switch, length 0.6 m	20189-103

Accessories for units

Foot switches

Two-pedal foot switch for ICC, ACC, T-series, AP & IP X8 equipment



with connecting cable 5 m, connecting plug 4 poles

No. 20189-009

= 1

30189-028



Two-pedal foot switch for ICC 80, ICC 50, ICC Bipolar, IP X8 equipment



without AP protection, with connecting cable 5 m,
with connecting plug 4 poles

No. 20187-003

= 1

30189-028



One-pedal foot switch for ICC, ACC, T-Series, AP & IP X8 equipment



with connecting cable 5 m, connecting plug 4 poles

No. 20188-007

= 1

30189-028



One-pedal foot switch, only for use with ICC 350, AP & IP X8 equipment



activation only 'bipolar', with connecting cable 5 m,
with connecting plug 4 poles

No. 20188-013

= 1

30189-028



Accessories for units

Foot switches

One-pedal foot switch for ICC, ACC, IP X8 equipment



without AP protection, with connecting cable 3 m,
with connecting plug 4 poles

No. 20186-007

= 1

30189-028



Foot switch adapter from VIO D/S to ICC two-pedal foot switch (4 poles), length 0.7 m

for OR-System e.g. DaVinci



No. 20140-004

= 1

30140-212



Foot switch adapter from VIO D/S to ICC one-pedal foot switch (7 poles), length 0.7 m

for OR-System e.g. DaVinci



No. 20140-007

= 1

30140-212



Accessories for units

Upgrades

VIO Upgrades for VIO D from V.2.x	No.
VIO Upgrade Interface	20140-006
VIO Upgrade Connector BiClamp	29140-214
VIO Upgrade Connector DRY CUT	29140-215
VIO Upgrade Connector TWINCOAG	29140-216
VIO Upgrade Connector PRECISE	29140-217
VIO Upgrade Connector ENDO CUT	29140-218

Socket modules

Socket modules	No.
Socket module MF-U, as an upgrade kit for VIO 3	20160-005
Socket module MF-0, as an upgrade kit for VIO 3	20160-004
Socket module MO 3Pin-9/5, as an upgrade kit for VIO 3	20160-001
Socket module MO 3Pin-Bovie, as an upgrade kit for VIO 3	20160-002
Socket module BI 2Pin 22-28-8/4, as an upgrade kit for VIO 3	20160-003
Socket module NE 6 - NE 2Pin, as an upgrade kit for VIO 3	20160-006
Assembly kit without socket, for APC 2 / VEM 2	20134-600
Assembly kit for second APC socket, for APC 2	20134-601
Socket module APC	20134-650
FiAPC socket module for APC 2	20134-651
Socket module BI 2Pin 22-28-8/4, as an upgrade kit	20140-613
Socket module MO 3Pin-Bovie, as an upgrade kit	20140-622
Socket module MO 3Pin-9/5, as an upgrade kit	20140-623
Cover MO 3Pin	20140-625
Complete Cover MO 3PIN	20140-626
Socket module MF-0, as an upgrade kit	20140-630
Socket module MF-2, as an upgrade kit for VIO 300 D	20140-633
Socket module NE 6 - NE 2Pin, as an upgrade kit	20140-642

Country-specific gas cylinder connectors APC 3, APC 2, APC 300

A

DIN 477, Nr. 6 m

for Afghanistan, Algeria, Andorra, Argentina **B***, Austria, Bangladesh **D***, Belgium, Bhutan, Brazil **B***, Brunei, Caribbean Countries, Chile **B***, China, Croatia, Cyprus, Czech Republic, Egypt, Estonia, France, Germany, Greece, Hungary, Iceland, India **D***, Indonesia, Iran, Ireland, Israel, Japan, Korea North, Korea South, Kuwait **D***, Latvia, Lebanon, Libya, Liechtenstein, Lithuania, Luxembourg, Macedonia, Malaysia, Malta, Mauritius, Morocco, Myanmar, Namibia, Nepal **D***, Oman **D***, Pakistan **D***, Peru **B***, Philippines, Poland, Portugal, Qatar **D***, Romania, Russia, Saudi Arabia **D***, Singapore, Slovakia, Slovenia, South Africa, Spain, Sri Lanka **D***, Sudan, Switzerland, Taiwan (ROC), Thailand **D***, Tunisia, Turkey, Ukraine, United Arab Emirates **D***, Uruguay, Vietnam **D***, Yemen **D***, Yugoslavia

B

CGA Nr. 580 m

for Argentina **A***, Bolivia, Brazil **A***, Canada, Chile **A***, Columbia, Dominican Republic, Ecuador, El Salvador, Guam, Guatemala, Haiti, Honduras, Italy, Mexico, New Zealand, Panama, Peru **A***, USA, Venezuela

C

DIN 477, Nr. 10 m

for Denmark, Finland, Ivory Coast, Netherlands, Norway, Sweden

D

BS 341, Nr. 3 m

for Australia, Bangladesh **A***, Great Britain, India **A***, Kuwait **A***, Nepal **A***, Northern Ireland, Oman **A***, Pakistan **A***, Qatar **A***, Saudi Arabia **A***, Sri Lanka **A***, Thailand **A***, United Arab Emirates **A***, Vietnam **A***, Yemen **A***

** further gas cylinder connectors possible*

Accessories for modules

APC pressure reducers and argon gas cylinders

Pressure reducer with sensor for APC 2/APC 3, with manual connection



gas cylinder connector to DIN 477 No. 6 m, W 21,8 outside,
with hose 0,5 m with manual connection

No. 20134-004

= 1

30134-008

A

Argon gas cylinder, 5 liters, empty



gas cylinder connector to DIN 477 No. 6 m
dimensions: height 60 cm, \varnothing 14 cm
weight 8,8 kg

No. 20132-171

= 1

A

Argon gas cylinder, 5 liters, 200 bar (2800 psi) filled with 4.8 argon gas (99,998%)



gas cylinder connector to DIN 477 No. 6 m
dimensions: height 60 cm, \varnothing 14 cm
weight 10,7 kg

No. 20132-004

= 1

A

Pressure reducer with sensor for APC 2/APC 3, with manual connection



gas cylinder connector to CGA No. 580 m, 0,965" inside,
with hose 0,5 m

No. 20134-002

= 1

30134-008

B

Accessories for modules

APC pressure reducers and argon gas cylinders

Argon gas cylinder, 5 liters, empty



gas cylinder connector to CGA No. 580 m
dimensions: height 60 cm, \varnothing 14 cm
weight: 8,1 kg

No. 20132-165

= 1

B

Pressure reducer with sensor for APC 2/APC 3, with manual connection



gas cylinder connector to DIN 477 No. 10 m, W 24,32 outside,
with hose 0,5 m with manual connection

No. 20134-001

= 1

30134-008

C

Pressure reducer with sensor for APC 2/APC 3, with manual connection



gas cylinder connector to BS 341 No. 3 m, G 5/8" inside,
with hose 0,5 m, with manual connection

No. 20134-003

= 1

30134-008

D

Pressure reducer with sensor for APC 2/APC 3



No. 20134-005

= 1

30134-008

Japan

Pressure reducer with sensor for APC 2/APC 3



No. 20134-006

= 1

30134-008

B

Accessories for modules

Further APC accessories

Pressure reducer with sensor for APC 2/APC 3, with manual connection



gas cylinder connector to ISO 5145 n°4,
with hose 0.75 m

No. 20134-007

= 1

D130245

France

Pressure reducer without sensor for APC 300, with manual connection



gas cylinder connector to ISO 5145 n°4,
with hose 0,75 m

No. 20132-078

= 1

D130245

France

Bacteriological filter set, APC 2, APC 300, 0.2 µm, steril



No. 20132-059

= 50

30132-275



STERILE EO

Connecting tube for central gas supply, APC 2/APC 3, APC 300, length 1 m



No. 20132-085

= 1

Socket modules

Socket module APC 2

No.

20134-650

FiAPC socket module for APC 2

20134-651

Accessories for modules

IES smoke evacuation system

Main filter cartridge IES 3 with connection \varnothing 22 mm



No. 20323-000

= 1

80114-801



Filter cartridge for IES 2, IES 300, with connection \varnothing 22 mm



No. 20321-000

= 1

30321-010



Prefilter for use with smoke evacuators, with connection \varnothing 22 mm



No. 20321-022

= 15



Smoke evacuation tubing \varnothing 32 mm, length 1.8 m, type VT 10106 for connection to central evacuation system



No. 20323-009

= 6

D147210



Suction hose, with connection \varnothing 22 mm, length 2.1 m



No. 20321-012

= 1

max 95 °C

max 134 °C

Suction hose, with connection \varnothing 22 mm, length 2.7 m



No. 20321-009

= 1

max 95 °C

max 134 °C

Evacuation tube, optimized streaming, with connection \varnothing 22 mm



No. 20321-004

= 1

max 95 °C

max 134 °C

Accessories for modules

IES smoke evacuation system

Evacuation funnel, with connection \varnothing 22 mm



No. 20321-010

= 1

max 95 °C

max 134 °C

T-piece, 22M - 22F - 22M for simultaneous application



No. 20323-005

= 20



D151174

STERILE EO

Hose coupling \varnothing 22 mm to \varnothing 22 mm



No. 20321-005

= 3

max 95 °C

max 134 °C

LAP tubing set IES 3 , with trumpet valve, 3 m, for laparoscopic application



No. 20323-003

= 10



D146821

STERILE EO

LAP tubing set IES 3, with trumpet valve, 5 m, for laparoscopic application



No. 20323-006

= 10



D146821

STERILE EO

LAP tubing set IES 3, without valve, 3 m, for laparoscopic application



No. 20323-010

= 10



D146821

STERILE EO

LAP tubing set IES 3, without valve, 5 m, for laparoscopic application



No. 20323-011

= 10



D146821

STERILE EO

Accessories for modules

IES smoke evacuation system

Evacuation element IES 3 for central evacuation



No. 20323-001

= 1



Automatic Activation Device for IES 3 for VIO C, electrosurgical external devices or stand-alone operation



No. 20323-002

= 1

D158940

Self-sealing water trap, right angled, medium volume for protecting the main filter cartridge



No. 20323-004

= 1

D139277



STERILE EO

Evacuation element with connector \varnothing 22 mm for IES 2



No. 20322-010

= 1



One-pedal foot switch for IES 2, AP & IP X8 equipment

with connecting cable 5 m, with connecting plug 7 poles



No. 20322-101

= 1

30189-301

max 75 °C



Power cord and foot switch cable

Power cord ICC / IES 300, length 0.35 m

No.

51704-033

Accessories for modules

IES smoke evacuation system

Smoke evacuation pencil, single use, short with spatula electrode, connecting cable 3 m



No. 20321-040

= 20

4.5 kVp

D150123

STERILE EO

Smoke evacuation pencil single use, short with coated spatula electrode, connecting cable 3 m



No. 20321-041

= 20

4.5 kVp

D150123

STERILE EO

Smoke evacuation pencil single use, short with spatula electrode, connecting cable 5 m



No. 20321-042

= 20

4.5 kVp

D150123

STERILE EO

Smoke evacuation pencil single use, short with coated spatula electrode, connecting cable 5 m



No. 20321-043

= 20

4.5 kVp

D150123

STERILE EO

Electrosurgical pencil with 2 buttons, VIO, ICC, ACC, ø 10 / 22 mm, International

with connecting cable 3 m, with spatula electrode and integrated smoke evacuationshaft extension 100 mm.

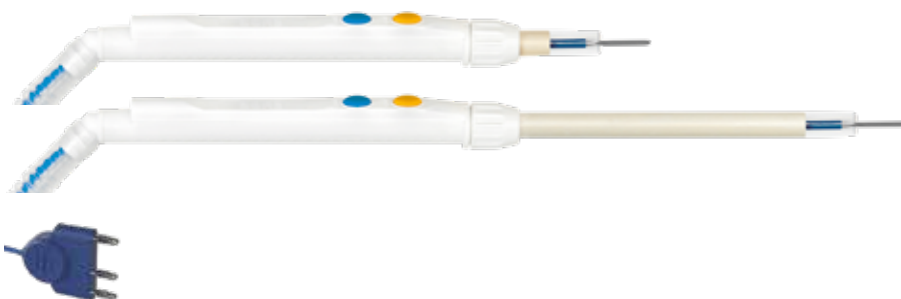

No. 20321-028

= 25

4.5 kVp

30321-001

STERILE EO

Accessories for modules

IES smoke evacuation system

Clip-On handle for smoke evacuation for 20190-065, -066, -067, -074, -075

To be used in combination with Erbe Slim-Line electro-surgical pencils (20190-065, 20190-066, 20190-067, 20190-074, 20190-075)



No. 20321-044

= 20

D150128



STERILE EO

Extension tip for Clip-On handle (20321-044)

To be used in combination with 20321-044



No. 20321-045

= 20

D150128



STERILE EO

Clip-on handle for Slim-Line electro-surgical pencils, tip short 12 mm

with evacuation tubing 3 m and connection \varnothing 22 mm, without electro-surgical pencil



No. 20321-007

= 25

30321-000



STERILE EO

Clip-on handle for Slim-Line electro-surgical pencils, tip long 100 mm

with evacuation tubing 3 m and connection \varnothing 22 mm, without electro-surgical pencil



No. 20321-020

= 25

30321-000



STERILE EO

Accessories for modules

EIP 2 irrigation pump

Tubing set EIP 2 for flexible endoscopes, with Luer Lock connection, length 2.5 m



replaces 20325-001

No. 20325-010

= 10

D148285



STERILE EO

Tubing set EIP 2 for irrigation forceps, without connecting cable, length 2.8 m



replaces 20325-020

No. 20325-011

= 10

D148285



STERILE EO

One-pedal foot switch for EIP 2, AP & IP X8 equipment



with connecting cable 3 m, connecting plug 4 poles

No. 20325-000

= 1

30189-028



Hook for irrigation liquid bag on bracket / VIO Cart



No. 20325-002

= 1

max 95 °C

max 134 °C

Accessories for modules

EIP 2 irrigation pump

Irrigation adapter for Olympus, Fujifilm G5, STORZ



No. 20325-003

 = 1

Irrigation adapter for Fujifilm



No. 20325-004

 = 1

Irrigation adapter for PENTAX



No. 20325-005

 = 1

Fastening sets

Fastening set EIP 2 / ESM 2 to VIO Cart 20180-000

No.

20180-135

Fastening set EIP 2 to Universal Cart

20185-203

Accessories for modules

Fluid management system

Reusable, with one suction unit



Single components	Pieces	No.
Silicone hose, length 600 mm	1	20340-004
Rail bracket, plastic	1	20340-002
Upper bracket for VIO CART, length 260 mm	1*	20180-040

* optional

Reusable, with two suction units



Single components	Pieces	No.
Silicone hose, length 600 mm	1	20340-004
Reversing valve, rail bracket with two silicone hoses, length 300 mm	1	20340-003
Rail bracket, plastic	2	20340-002
Lower bracket for VIO CART, length 390 mm	1	20180-042
Upper bracket for VIO CART, length 260 mm	1	20180-040

Accessories for modules

Fluid management system

ESM membrane filter



for use with silicone hose 20340-004

No. 20340-100

= 10



Silicone hose, length 600 mm



No. 20340-004

= 1

max 95 °C

max 134 °C

Rail bracket, plastic



for use with suction container 20340-102 and 20340-103

No. 20340-002

= 1

max 95 °C

max 134 °C

Switching valve, rail bracket and 2 silicone hoses, length 300 mm



No. 20340-003

= 1

max 95 °C

max 134 °C

Accessories for modules

Fluid management system

Suction container, 1.5 liters



for use with suction bag 20340-012

No. 20340-102

 = 1

Suction bag, 1.5 liters



for use with suction container 20340-102

No. 20340-012

 = 30



Suction bag, 2.5 liters



for use with suction container 20340-103

No. 20340-013

 = 30



Accessories for modules

Nerve test / NT 2

Electrosurgical pencil for nerve test with 1 button, for silver ball electrode, NT 2, ICC 350 ZMK

with connecting cable 4 m



No. 20190-148

= 1

0.25 kVp

max 95 °C

30190-262

max 138 °C

Silver ball electrode for nerve test, \varnothing 1 mm, length 40 mm



Shape / Forming

straight

Piece

1

No.

21191-052

Patient plates for NT 2, without connecting cable



No. 20142-200

= 20



Patient plate cable for NT 2, length 5 m



No. 20142-100

= 1



Test box

Test box 3 for checking of electrosurgical accessories



No. 20183-042

= 1

Important information

The information, recommendations and other details contained in this medium ("information") reflect our state of knowledge and the state of the art in science and technology at the time the medium was created. The information is of a general nature, non-binding and intended solely for general information purposes; it does not constitute instructions for use.

The information and recommendations contained in this medium do not create any legal obligations on the part of Erbe Elektromedizin GmbH and its affiliated companies ("Erbe") or any other claims against Erbe. The information does not constitute any guarantees or other information on the nature of the product; such information requires an express contractual agreement with Erbe in each individual case.

Erbe is not liable for any kind of damage resulting from following the information on this medium, regardless of any legal grounds for liability.

Every user of an Erbe product is responsible for testing the respective Erbe product in advance with regard to its properties and its suitability for the intended type of use or purpose. Suitable type of use of the respective Erbe product can be found in the instructions for use for the respective Erbe product. The user is obliged to ascertain whether the instructions for use available to him/her correspond to the current status of the specific Erbe product. Devices may only be used in accordance with the instructions for use.

Information on settings, application sites, application duration and use of the respective Erbe product is based on the clinical experience of individual centers, physicians and clinical literature independent of Erbe as well as post market surveillance and empirical evidence. They constitute reference values, or Experienced Starting Settings, which must be checked by the user to ensure that they are suitable for the specifically planned application. Depending on the circumstances of a specific application, it may be necessary to deviate from the information provided. The user is responsible for checking this when using Erbe products. We wish to note that science and technology are subject to constant development as a result of research and clinical experience. Similarly, medicine and clinical application are constantly evolving as a result of research and technological development. This may also make it necessary for the user to deviate from the information provided on this medium.

This medium contains information about Erbe products that may not be approved/cleared in certain countries. The user of the respective Erbe product is obliged to inform himself/herself as to whether the Erbe product he/she is using is legally approved/cleared in his/her country and/or to what extent, if any, there are legal requirements for or restrictions on its use.

This medium is not intended for use in the USA.

Erbe Elektromedizin GmbH
Waldhoernlestrasse 17
72072 Tuebingen
Germany

Phone +49 7071 755-0
info@erbe-med.com
erbe-med.com
medical-videos.com



**Instruments
and accessories**

for vessel sealing

Legend

Important notes

The authors and Erbe Elektromedizin GmbH have taken the greatest possible care while compiling the catalogue with electrosurgical accessories. Nevertheless, it is impossible to exclude the possibility that errors may be contained herein.

The information and recommendations given here may not be construed as constituting any basis for any claims against Erbe Elektromedizin GmbH. Should legal regulations stipulate liability, such liability shall be limited to intentional misconduct or gross negligence.

The data on the use of instruments is based on clinical experience. Medical science is subject to a process of permanent change based on research and clinical experience. Therefore the products are subject to alterations in design and technique. Because of production tolerances dimensions in the catalogue may marginally differ.

We confirm that none of our products contain latex, except the rubber straps, Art. No. 20592-009 and 20592-011.

Further product information

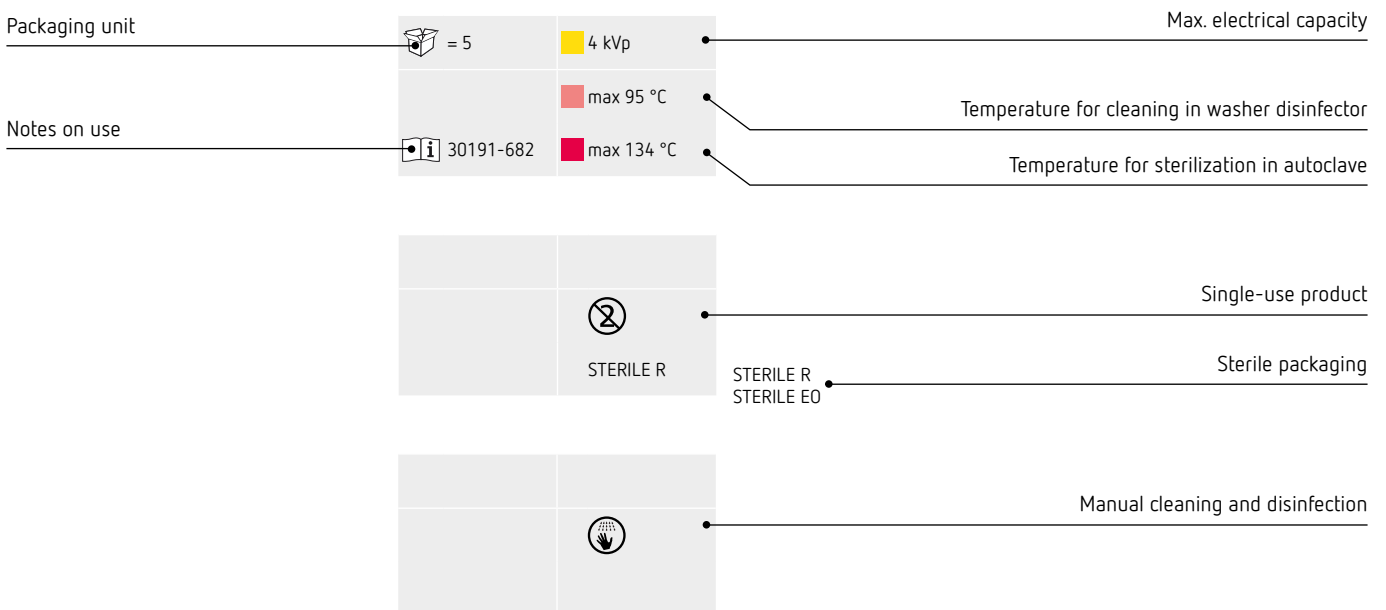

Please read carefully the corresponding notes on use before using any instrument.

Vessel sealing

Instruments and accessories

- 04 BiClamp
- 12 BiCision
- 13 BiClamp LAP forceps
- 17 BiClamp E LAP forceps
- 19 Accessories for treatment for BiClamp LAP and BiClamp E LAP forceps

Overview

Field of application

Open surgery

Laparoscopy

Open surgery and laparoscopy

Shape of instrument

BiClamp

BiClamp LAP and BiClamp E LAP

BiCision

Electrosurgical unit

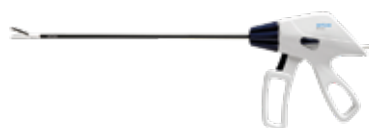

BiClamp



150 mm

200 mm

BiClamp



BiClamp



100 %

270 mm

280 mm

Instruments and accessories

BiClamp

BiClamp



No.



= 1







0.25 kVp

max 95 °C

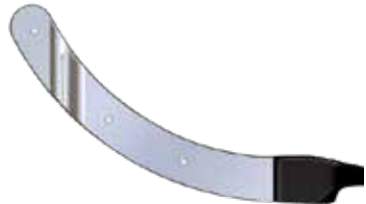

30195-122

max 138 °C

Product type		Length	Shape	Jaws	No.
BiClamp 150 C		150 mm	bent 23°	smooth	20195-221 21195-221
BiClamp 190 C		190 mm	bent 23°	smooth	21195-190
BiClamp 201 T		200 mm	bent 18°	smooth	20195-202 21195-202
BiClamp 210		210 mm	bent 25°	corrugated	20195-200 21195-200
BiClamp 260 C		260 mm	bent 18°	smooth	20195-299 21195-299
BiClamp 271 T		270 mm	bent 18°	smooth	20195-203 21195-203
BiClamp 280		280 mm	bent 25°	smooth	20195-280 21195-280

100 %

Instruments and accessories

BiClamp

BiClamp 150 C, bent 23°, smooth, length 150 mm

with connecting cable 4 m and MF plug, with ceramic coating, e.g. for thyroidectomy



No. 20195-221



= 1

0.25 kVp

max 95 °C



30195-122

max 138 °C

BiClamp 201 T, bent 18°, smooth, length 200 mm

with connecting cable 4 m and MF plug, with thermal insulation, for open surgical procedures, e.g. intestinal surgery



No. 20195-202



= 1

0.25 kVp

max 95 °C



30195-122

max 138 °C

BiClamp 210, bent 25°, smooth, length 210 mm

with connecting cable 4 m and MF plug, with corrugated surfaces, e.g. for vaginal hysterectomy



No. 20195-200



= 1

0.25 kVp

max 95 °C



30195-122

max 138 °C

Instruments and accessories

BiClamp

BiClamp 260 C, bent 18°, smooth, length 260 mm

with connecting cable 4 m and MF plug, with ceramic coating, e.g. for prostatectomy or pediatric surgery



No. 20195-299



= 1

0.25 kVp

max 95 °C



30195-122

max 138 °C

BiClamp 271 T, bent 18°, smooth, length 270 mm

with connecting cable 4 m and MF plug, with thermal insulation, for open surgical procedures, e.g. intestinal surgery

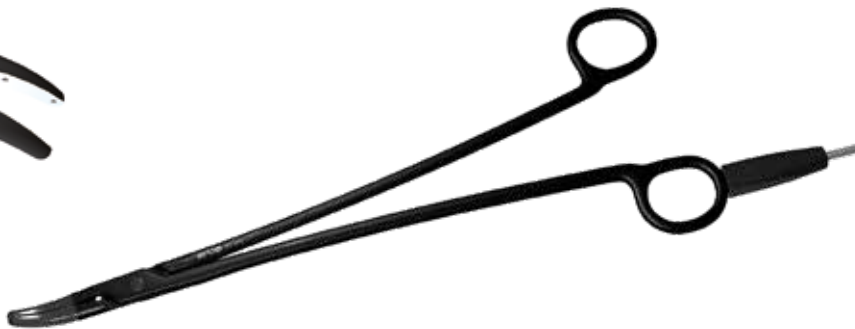

No. 20195-203



= 1

0.25 kVp

max 95 °C



30195-122

max 138 °C

BiClamp 280, bent 25°, smooth, length 280 mm

with connecting cable 4 m and MF plug. e.g. for open cystectomy or prostatectomy

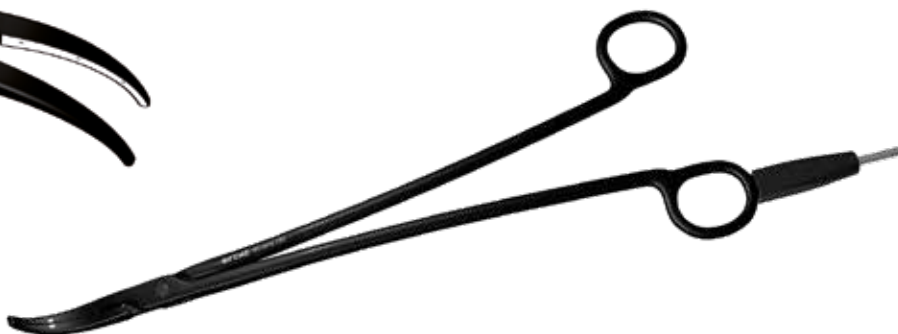

No. 20195-280



= 1

0.25 kVp

max 95 °C



30195-122

max 138 °C

Instruments and accessories

BiClamp

BiClamp 150 C, MF-2, bent 23°, smooth, length 150 mm

with connecting cable 4 m and MF-2 plug, with ceramic coating, e.g. for thyroidectomy



No. 21195-221



0.25 kVp

max 95 °C



31195-002

max 138 °C

BiClamp 190 C, MF-2, bent 23°, smooth, length 190 mm

with connecting cable 4 m and MF-2 plug, with ceramic coating, e.g. for thyroidectomy



No. 21195-190



0.25 kVp

max 95 °C



31195-002

max 138 °C

BiClamp 201 T, MF-2, bent 18°, smooth, length 200 mm

with connecting cable 4 m and MF-2 plug, with thermal insulation, for open surgical procedures, e.g. intestinal surgery



No. 21195-202



0.25 kVp

max 95 °C



31195-002

max 138 °C

BiClamp 210, MF-2, bent 25°, smooth, length 210 mm

with connecting cable 4 m and MF-2 plug, with corrugated surfaces, e.g. for vaginal hysterectomy



No. 21195-200



0.25 kVp

max 95 °C



31195-003

max 138 °C

Instruments and accessories

BiClamp

BiClamp 260 C, MF-2, bent 18°, smooth, length 260 mm

with connecting cable 4 m and MF-2 plug, with ceramic coating, e.g. for prostatectomy or pediatric surgery

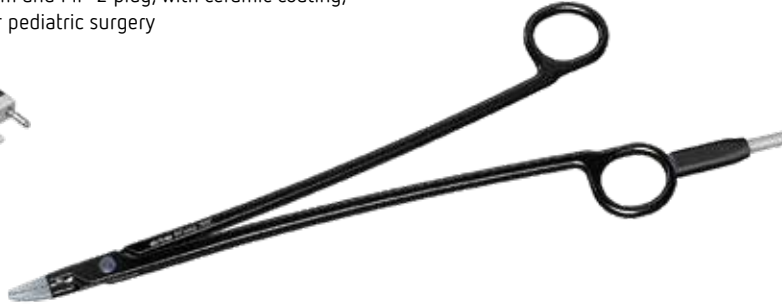

No. 21195-299

= 1

0.25 kVp

max 95 °C

31195-003

max 138 °C

BiClamp 271 T, MF-2, bent 18°, smooth, length 270 mm

with connecting cable 4 m and MF-2 plug, with thermal insulation, for open surgical procedures, e.g. intestinal surgery



No. 21195-203

= 1

0.25 kVp

max 95 °C

31195-002

max 138 °C

BiClamp 280, MF-2, bent 25°, smooth, length 280 mm

with connecting cable 4 m and MF-2 plug, e.g. for open cystectomy or prostatectomy



No. 21195-280

= 1

0.25 kVp

max 95 °C

31195-003

max 138 °C

Adapters

Adapter, MF-socket, MF-2-plug
for VIO 300 D



Piece

1

No.

20183-100

Adapter, MF-2/MF-U-socket, MF-plug
for VIO 3 and VIO 300 D



1

20183-101

Instruments and accessories

BiCision

BiCision S, ø 5 mm, shaft length 200 mm

with connecting cable 4 m and MF plug, for open and laparoscopic procedures



No. 20195-310

= 5

0.25 kVp

30195-331



STERILE EO

BiCision M, ø 5 mm, shaft length 350 mm

with connecting cable 4 m and MF plug, for open and laparoscopic procedures



No. 20195-311

= 5

0.25 kVp

30195-331



STERILE EO

BiCision L, ø 5 mm, shaft length 450 mm

with connecting cable 4 m and MF plug, for open and laparoscopic procedures

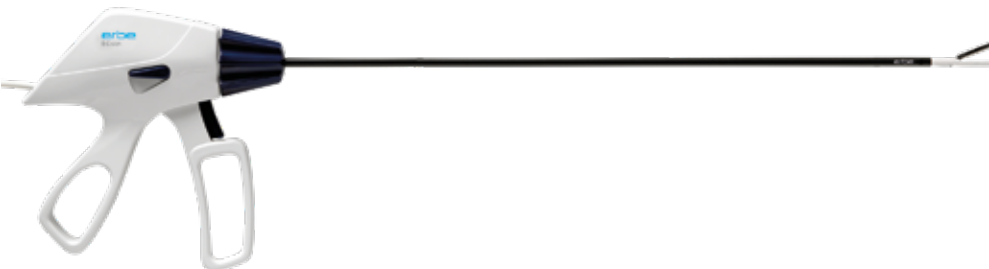

No. 20195-312

= 5

0.25 kVp

30195-331



STERILE EO

Instruments and accessories

BiClamp LAP forceps

BiClamp LAP forceps, Maryland, semi-deep ribbed, shaft \varnothing 5 mm, non-adhesive coating, length 340 mm
with connecting cable 4 m and MF plug, complete instrument



No. 20195-134

= 1	0.25 kVp
30195-119	max 95 °C
	max 138 °C

BiClamp LAP forceps, Maryland, smooth, shaft \varnothing 5 mm, non-adhesive coating, length 340 mm
with connecting cable 4 m and MF plug, complete instrument



No. 20195-135

= 1	0.25 kVp
30195-119	max 95 °C
	max 138 °C

BiClamp LAP forceps, fenestrated, semi-deep, shaft \varnothing 5 mm, non-adhesive coating, length 340 mm
with connecting cable 4 m and MF plug, complete instrument



No. 20195-136

= 1	0.25 kVp
30195-119	max 95 °C
	max 138 °C

BiClamp LAP forceps, fenestrated, smooth, shaft \varnothing 5 mm, non-adhesive coating, length 340 mm
with connecting cable 4 m and MF plug, complete instrument



No. 20195-137

= 1	0.25 kVp
30195-119	max 95 °C
	max 138 °C

Instruments and accessories

BiClamp LAP forceps

BiClamp LAP forceps, Kelly, semi-deep, shaft \varnothing 5 mm, non-adhesive coating, length 340 mm

with connecting cable 4 m and MF plug



No. 20195-228



= 1

0.25 kVp

max 95 °C



30195-119

max 138 °C

BiClamp 110, smooth, shaft \varnothing 5 mm, non-adhesive coating, length 110 mm

with connecting cable 4 m and MF-plug, complete instrument,
e.g. for minimally invasive thyroidectomy (MIVAT)



No. 20195-230



= 1

0.25 kVp

max 95 °C



30195-096

max 138 °C

Instruments and accessories

BiClamp LAP forceps

BiClamp LAP forceps, Maryland, MF-2, semi-deep ribbed, shaft \varnothing 5 mm, non-adhesive coating, length 340 mm
with connecting cable 4 m and MF-2 plug, complete instrument



No. 21195-134



0.25 kVp

max 95 °C



30195-119

max 138 °C

BiClamp LAP forceps, Maryland, MF-2, smooth, shaft \varnothing 5 mm, non-adhesive coating, length 340 mm
with connecting cable 4 m and MF-2 plug, complete instrument



No. 21195-135



0.25 kVp

max 95 °C



30195-119

max 138 °C

BiClamp LAP forceps, fenestrated, MF-2, semi-deep, shaft \varnothing 5 mm, non-adhesive coating, length 340 mm
with connecting cable 4 m and MF-2 plug, complete instrument



No. 21195-136



0.25 kVp

max 95 °C



30195-119

max 138 °C

BiClamp LAP forceps, fenestrated, MF-2, smooth, shaft \varnothing 5 mm, non-adhesive coating, length 340 mm
with connecting cable 4 m and MF-2 plug, complete instrument



No. 21195-137



0.25 kVp

max 95 °C



30195-119

max 138 °C

BiClamp LAP forceps, Kelly, MF-2, semi-deep, shaft \varnothing 5 mm, non-adhesive coating, length 340 mm
with connecting cable 4 m and MF-2 plug, complete instrument



No. 21195-228



0.25 kVp

max 95 °C



30195-119

max 138 °C

Instruments and accessories

BiClamp LAP forceps

BiClamp 110, MF-2, smooth, shaft \varnothing 5 mm, non-adhesive coating, length 110 mm

with connecting cable 4 m and MF-2 plug, complete instrument, e.g. for minimally invasive thyroidectomy (MIVAT)



No. 21195-230

= 1

0.25 kVp

max 95 °C

30195-119

max 138 °C

Single components		Piece	No.
Insert for BiClamp LAP forceps, Kelly, shaft \varnothing 5 mm, length 340 mm (for 20195-228)		1	20195-236
Insert for BiClamp LAP forceps, Maryland, semi-deep ribbed, shaft \varnothing 5 mm, length 340 mm (for 20195-134)		1	20195-146
Insert for BiClamp LAP forceps, Maryland, smooth, shaft \varnothing 5 mm, length 340 mm (for 20195-135)		1	20195-147
Insert for BiClamp LAP forceps, fenestrated, semi-deep, shaft \varnothing 5 mm, length 340 mm (for 20195-136)		1	20195-148
Insert for BiClamp LAP forceps, fenestrated, smooth, shaft \varnothing 5 mm, length 340 mm (for 20195-137)		1	20195-149
Insert for BiClamp 110, smooth, shaft \varnothing 5 mm, length 110 mm (for 20195-230)		1	20195-232
Shaft tube for bipolar LAP forceps and BiClamp LAP forceps		1	20195-141
Shaft tube for BiClamp 110, \varnothing 5 mm, length 110 mm (for 20195-230)		1	20195-234
Handle for BiClamp LAP forceps and BiClamp 110, with connecting cable 4 m and MF plug		1	20195-145
Handle for BiClamp LAP forceps and BiClamp 110, with connecting cable 4 m and MF-2 plug		1	21195-145

Adapters		Piece	No.
Adapter, MF-socket, MF-2-plug for VIO 300 D		1	20183-100
Adapter, MF-2/MF-U-socket, MF-plug for VIO 3 and VIO 300 D		1	20183-101

Instruments and accessories

BiClamp E LAP forceps

BiClamp E LAP forceps, Maryland, semi-deep, shaft \varnothing 5 mm, length 340 mm

with connecting cable 4 m and MF plug



No. 20195-246



= 1

0.25 kVp

max 95 °C



30195-119

max 138 °C

BiClamp E LAP forceps, Maryland, smooth, shaft \varnothing 5 mm, length 340 mm

with connecting cable 4 m and MF plug



No. 20195-247



= 1

0.25 kVp

max 95 °C



30195-119

max 138 °C

BiClamp E LAP forceps, fenestrated, semi-deep, \varnothing 5 mm, length 340 mm

with connecting cable 4 m and MF plug



No. 20195-248



= 1

0.25 kVp

max 95 °C



30195-096

max 138 °C

BiClamp E LAP forceps, fenestrated, smooth, shaft \varnothing 5 mm, length 340 mm

with connecting cable 4 m and MF plug



No. 20195-249



= 1

0.25 kVp

max 95 °C



30195-096

max 138 °C

BiClamp E LAP forceps, Kelly, semi-deep, shaft \varnothing 5 mm, length 340 mm

with connecting cable 4 m and MF plug



No. 20195-229

0.25 kVp

max 95 °C



30195-119

max 138 °C

Instruments and accessories

BiClamp E LAP forceps

BiClamp E LAP forceps, Maryland, MF-2, semi-deep, shaft \varnothing 5 mm, length 340 mm

with connecting cable 4 m and MF-2 plug



No. 21195-246



= 1

0.25 kVp

max 95 °C



30195-119

max 138 °C

BiClamp E LAP forceps, Maryland, MF-2, smooth, shaft \varnothing 5 mm, length 340 mm

with connecting cable 4 m and MF-2 plug



No. 21195-247



= 1

0.25 kVp

max 95 °C



30195-119

max 138 °C

BiClamp E LAP forceps, fenestrated, MF-2, semi-deep, \varnothing 5 mm, length 340 mm

with connecting cable 4 m and MF-2 plug



No. 21195-248



= 1

0.25 kVp

max 95 °C



30195-119

max 138 °C

BiClamp E LAP forceps, fenestrated, MF-2, smooth, shaft \varnothing 5 mm, length 340 mm

with connecting cable 4 m and MF-2 plug



No. 21195-249



= 1

0.25 kVp

max 95 °C



30195-119

max 138 °C

BiClamp E LAP forceps, Kelly, MF-2, semi-deep, shaft \varnothing 5 mm, length 340 mm

with connecting cable 4 m and MF-2 plug



No. 21195-229

0.25 kVp

max 95 °C













30195-119

max 138 °C



Instruments and accessories

BiClamp E LAP forceps

Single components		Piece	No.
Insert for BiClamp E LAP forceps, Kelly, shaft \varnothing 5 mm, length 340 mm (for 20195-229, 21195-229)		1	20195-236
Insert for BiClamp E LAP forceps, Maryland, semi-deep ribbed, shaft \varnothing 5 mm, length 340 mm (for 20195-246, 21195-246)		1	20195-146
Insert for BiClamp E LAP forceps, Maryland, smooth, shaft \varnothing 5 mm, length 340 mm (for 20195-247, 21195-247)		1	20195-147
Insert for BiClamp E LAP forceps, fenestrated, semi-deep, shaft \varnothing 5 mm, length 340 mm (for 20195-248, 21195-248)		1	20195-148
Insert for BiClamp E LAP forceps, fenestrated, smooth, shaft \varnothing 5 mm, length 340 mm (for 20195-249, 21195-249)		1	20195-149
Shaft tube for BiClamp E LAP forceps, \varnothing 5 mm, length 340 mm		1	20195-241
Handle for BiClamp E LAP forceps, with connecting cable 4 m and MF plug (for 20195-246, 20195-247, 20195-248, 20195-249, 20195-229)		1	20195-240
Handle for BiClamp E LAP forceps, with connecting cable 4 m and MF-2 plug (for 21195-246, 21195-247, 21195-248, 21195-249, 21195-229)		1	21195-240

Adapters		Piece	No.
Adapter, MF-socket, MF-2-plug for VIO 300 D		1	20183-100
Adapter, MF-2/MF-U-socket, MF-plug for VIO 3 and VIO 300 D		1	20183-101

Accessories for treatment for BiClamp LAP and BiClamp E LAP forceps

Accessories for treatment		Piece	No.
Cleaning brush for suction channel max. \varnothing 3.5 mm, length 650 mm, for manual cleaning and disinfection		1	20191-279
Irrigation tube for shaft tube with Luer Lock connector, length 500 mm, for LAP instruments, for cleaning and disinfection by machine		1	20195-201

Important information

We have prepared this document with care. Nonetheless, we cannot completely rule out errors in this document.

The information, recommendations and other data ("Information") contained in this document reflect our state of knowledge and the state of science and technology at the time of preparing the document. The information is of a general nature, non-binding and serves solely for general information purposes and does not represent instructions for use or notes on application.

The information and recommendations contained in this document do not constitute any legal obligations by Erbe Elektromedizin GmbH as well as their associated companies ("Erbe") or any other claims against Erbe. The information does not represent a guarantee or other quality statement, these require the express contractual arrangement with Erbe in individual cases.

Erbe shall not be liable for any type of damage resulting from following information given in this document, regardless of the legal reason for liability.

Every user of an Erbe product is responsible for checking the respective Erbe product for its properties as well as the suitability for the intended type of application or intended purpose in advance. The suitable type of application of the respective Erbe product is given by the user manual and the notes on use for the corresponding Erbe product. The user is obliged to check whether the existing user manual and the notes on use correspond with the status for the specific Erbe product. The devices may only be used according to the user manual and the notes on use.

The information on setting values, application sites, duration of application and the use of the respective Erbe product is based on the clinical experience of physicians independent from Erbe. They represent guidelines which need to be checked by the user for their suitability for the actual planned application. Depending on the circumstances of an actual application case, it may be necessary to deviate from the information provided. The user has to check this on his/her own responsibility in each case when using an Erbe product. We wish to point out that science and technology is constantly subject to new developments arising from research and clinical experience. For this reason it may be necessary for the user to deviate from the information provided in this document.

This document contains information about Erbe products which may possibly not be approved in a specific country. The user of the respective Erbe product is obliged to inform him/herself whether the Erbe product he/she is using is legally approved in his/her country and/or if legal requirements or restrictions for use possibly exist and to which extent.

This document is not intended for users in the USA.

Erbe Elektromedizin GmbH
Waldhoernlestrasse 17
72072 Tuebingen
Germany

Phone +49 7071 755-0
Fax +49 7071 755-179
info@erbe-med.com
erbe-med.com

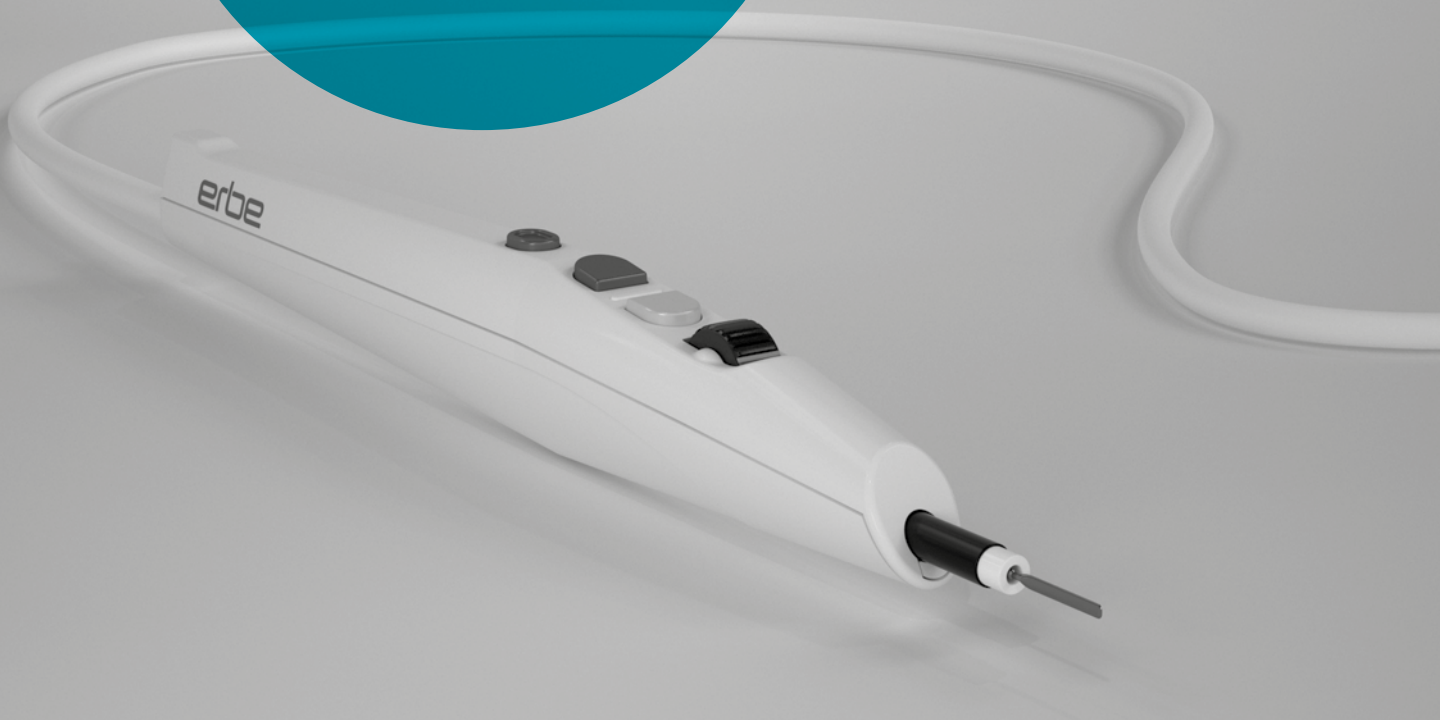

Important notes

The authors and Erbe Elektromedizin GmbH have taken the greatest possible care while compiling the catalogue with electrosurgical accessories. Nevertheless, it is impossible to exclude the possibility that errors may be contained herein.

The information and recommendations given here may not be construed as constituting any basis for any claims against Erbe Elektromedizin GmbH. Should legal regulations stipulate liability, such liability shall be limited to intentional misconduct or gross negligence.

The data on the use of instruments is based on clinical experience. Medical science is subject to a process of permanent change based on research and clinical experience. Therefore the products are subject to alterations in design and technique. Because of production tolerances dimensions in the catalogue may marginally differ.

We confirm that none of our products contain latex, except the rubber straps, Art. No. 20592-009 and 20592-011.

Further product information

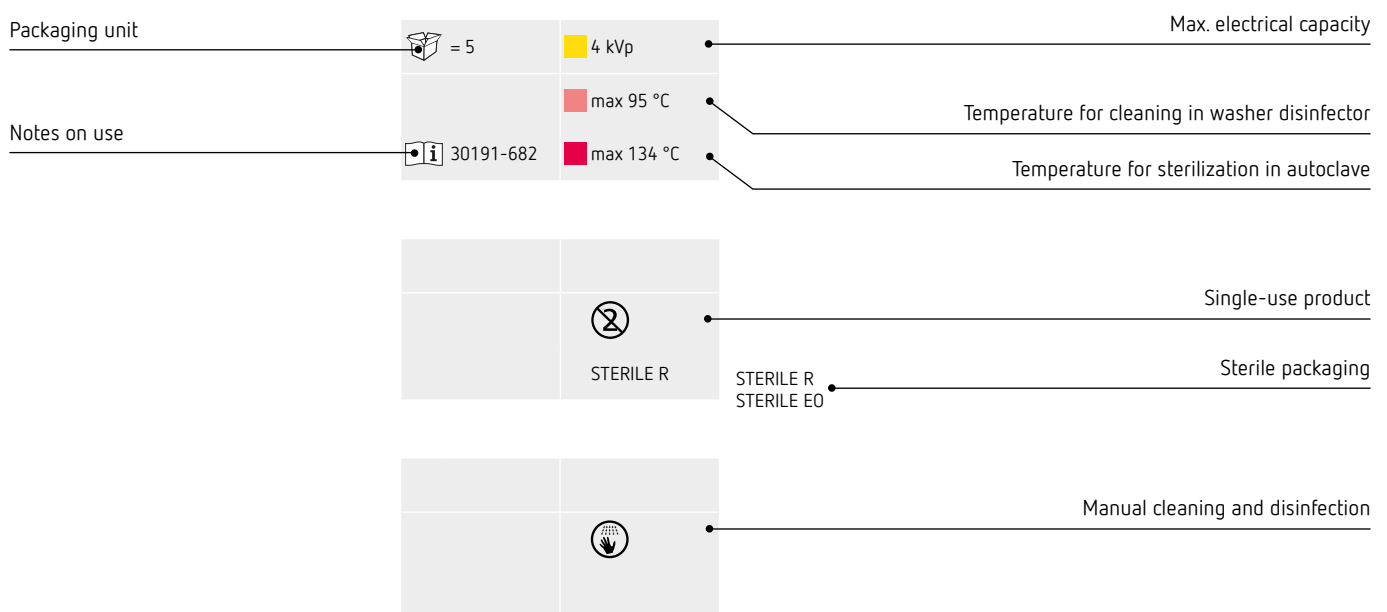

Please read carefully the corresponding notes on use before using any instrument.

Argon plasma coagulation

Instruments for APC

- 04 FiAPC probes, single-use
- 07 Flexible APC probes, single-use
- 09 APCapplicator
- 11 APC applicators for APC handles
- 14 APC ignition test adapters
- 15 APC applicators for APC connecting cables

Accessories for APC

- 17 APC pressure reducers and argon gas cylinder / further APC accessories

Overview

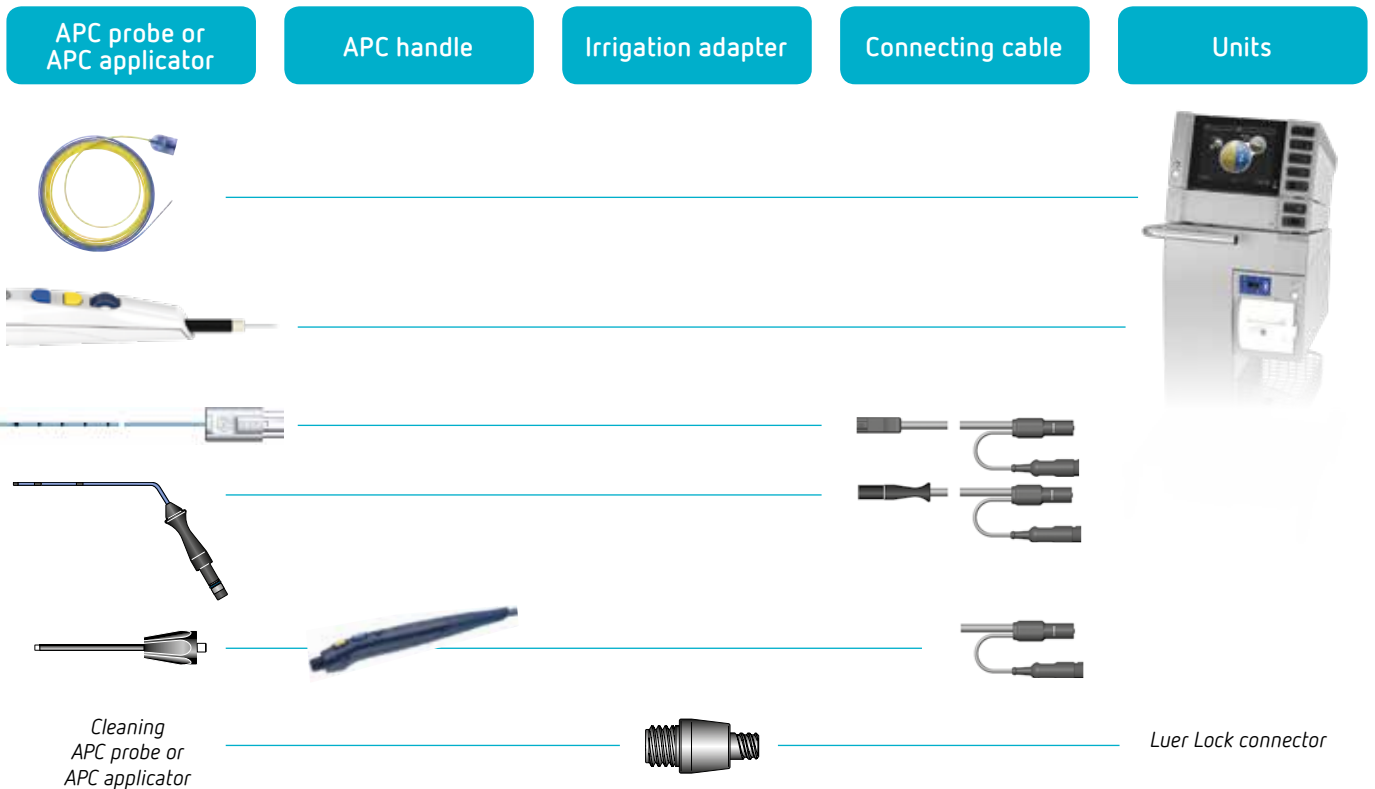

Instruments for APC

Beam forms



Axial beam
A



Side Fire Conical Beam
SC

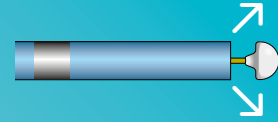

Circumferential Beam
C

FiAPC probes, single-use

FiAPC probe 1500 A, \varnothing 1.5 mm, flexible, length 1.5 m



with instrument recognition and integrated filter,
e.g. for bronchoscopy

No. 20132-220

= 10

5 kVp

30132-344



STERILE EO

FiAPC probe 2200 A, \varnothing 2.3 mm, flexible, length 2.2 m



with instrument recognition and integrated filter

No. 20132-221

= 10

5 kVp

30132-344



STERILE EO

Instruments for APC

FiAPC probes, single-use

FiAPC probe 2200 A, \varnothing 3.2 mm, flexible, length 2.2 m



with instrument recognition and integrated filter

No. 20132-222

= 10

5 kVp

30132-344



STERILE EO

FiAPC probe 3000 A, \varnothing 2.3 mm, flexible, length 3 m



with instrument recognition and integrated filter

No. 20132-223

= 10

5 kVp

30132-344



STERILE EO

FiAPC probe 2200 SC, \varnothing 2.3 mm, flexible, length 2.2 m



with instrument recognition and integrated filter

No. 20132-224

= 10

5 kVp

30132-344



STERILE EO

Instruments for APC

FiAPC probes, single-use

FiAPC probe 2200 C, \varnothing 2.3 mm, flexible, length 2.2 m



with instrument recognition and integrated filter

No. 20132-225

= 10

5 kVp

30132-344



STERILE EO

FiAPC probe 3000 A, \varnothing 1.5 mm, flexible, length 3 m



with instrument recognition and integrated filter,
e.g. for double-balloon enteroscopy

No. 20132-226

= 10

5 kVp

30132-344



STERILE EO

Adapter for FiAPC probes



for connection with APC 2 / APC 300

No. 20132-227

= 1

4.3 kVp

30132-346

max 95 °C

max 138 °C

Instruments for APC

Flexible APC probes, single-use

APC probe 1500 A, \varnothing 1.5 mm, flexible, length 1.5 m

with instrument recognition, e.g. for bronchoscopy



No. 20132-155

= 10

4 kVp

30132-309



STERILE EO

APC probe 3000 A, \varnothing 1.5 mm, flexible, length 3 m

with instrument recognition, e.g. for double-balloon enteroscopy



No. 20132-212

= 10

4 kVp

30132-309



STERILE EO

APC probe 2200 A, \varnothing 2.3 mm, flexible, length 2.2 m

with instrument recognition



No. 20132-156

= 10

4.3 kVp

30132-309



STERILE EO

APC probe 3000 A, \varnothing 2.3 mm, flexible, length 3 m

with instrument recognition



No. 20132-166

= 10

4.3 kVp

30132-309



STERILE EO

APC probe 2200 SC, \varnothing 2.3 mm, flexible, length 2.2 m

with instrument recognition



No. 20132-167

= 10

4.3 kVp

30132-309



STERILE EO

Instruments for APC

Flexible APC probes, single-use

APC probe 2200 C, ø 2.3 mm, flexible, length 2.2 m

with instrument recognition

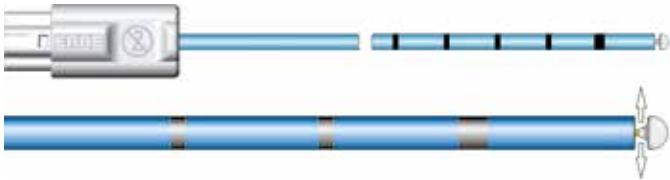

No. 20132-186

= 10

4.3 kVp

30132-309



STERILE EO

APC probe 2200 A, ø 3.2 mm, flexible, length 2.2 m

with instrument recognition



No. 20132-157

= 10

4.3 kVp

30132-309



STERILE EO

APC connecting cable/irrigation adapter	Length	Piece	No.
Bacteriological filter set, APC 2, APC 300, 0.2 µm, steril		50	20132-059
Connecting cable for flexible APC probes, APC 2/VIO, APC 300/ICC	2.5 m	1	20132-158
Irrigation adapter for flexible APC probes with Luer-Lock, for APC probes with APC connecting cable 20132-158		5	20132-203

Flexible APC probes, single-use
are not compatible with VIO 3/APC 3

Instruments for APC

APCapplicator

APCapplicator, with filter, shaft 35 mm, rigid, spatula electrode

ReMode, with connecting cable 3 m



No. 20132-250



4.3 kVp

30132-478



STERILE EO

APCapplicator, with filter, shaft 35 mm, rigid, needle electrode

ReMode, with connecting cable 3 m



No. 20132-251



4.3 kVp

30132-478



STERILE EO

APCapplicator, with filter, shaft 100 mm, rigid, spatula electrode

ReMode, with connecting cable 3 m



No. 20132-252



4.3 kVp

30132-478



STERILE EO

APCapplicator, with filter, shaft 100 mm, rigid, needle electrode

ReMode, with connecting cable 3 m



No. 20132-253



4.3 kVp

30132-478



STERILE EO

Instruments for APC

APCapplicator

APCapplicator, with filter, shaft 350 mm, rigid, spatula electrode

ReMode, with connecting cable 3 m



No. 20132-254



= 5

4.3 kVp



30132-478

STERILE EO

APCapplicator, with filter, shaft 350 mm, rigid, needle electrode

ReMode, with connecting cable 3 m



No. 20132-255



= 5

4.3 kVp



30132-478

STERILE EO

APCapplicator, with filter, shaft 100 mm, bendable, 1 button (coagulation)



No. 20132-256



= 5

4.3 kVp



30132-478

STERILE EO

Adapter for connection to APC 2 with standard APC socket



No. 20132-249



= 1

4.3 kVp

max 95 °C



30132-491

max 138 °C

Instruments for APC

APC applicators for APC handles

APC applicator, \varnothing 5 mm, rigid, length 25 mm

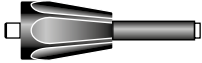

No. 20132-031



= 1

4.3 kVp

max 95 °C



30132-041

max 138 °C

APC applicator, \varnothing 5 mm, rigid, length 100 mm



No. 20132-032



= 1

4.3 kVp

max 95 °C



30132-041

max 138 °C

APC applicator, \varnothing 5 mm, rigid, length 320 mm



No. 20132-034



= 1

4.3 kVp

max 95 °C



30132-041

max 138 °C

APC applicator, \varnothing 5 mm, rigid, length 320 mm

with hook electrode



No. 20132-084



= 1

4.3 kVp

max 95 °C



30132-041

max 138 °C

Instruments for APC

APC applicators for APC handles

APC applicator, ø 5 mm, rigid, length 35 mm

with adjustable needle electrode

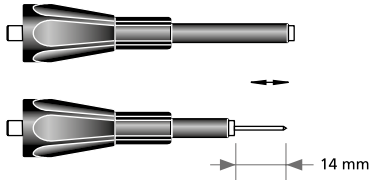

No. 20132-054



= 1

4.3 kVp

max 95 °C



30132-041

max 138 °C

APC applicator, ø 5 mm, rigid, length 35 mm

with adjustable spatula

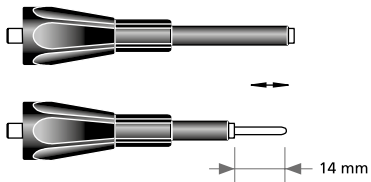

No. 20132-057



= 1

4.3 kVp

max 95 °C



30132-041

max 138 °C

APC applicator, ø 5 mm, rigid, length 100 mm

with adjustable needle

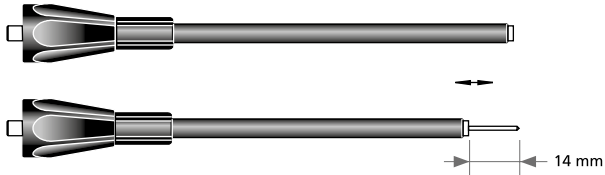

No. 20132-044



= 1

4.3 kVp

max 95 °C



30132-041

max 138 °C

APC applicator, ø 5 mm, rigid, length 100 mm

with adjustable spatula

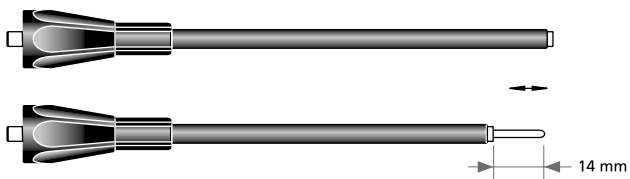

No. 20132-056



= 1

4.3 kVp

max 95 °C



30132-041

max 138 °C

Instruments for APC

APC applicators for APC handles

APC applicator, ø 5 mm, rigid, length 220 mm

with adjustable needle

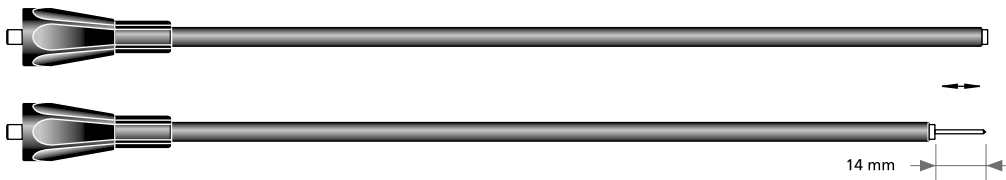

No. 20132-211



= 1

4.3 kVp

max 95 °C



30132-332

max 138 °C

APC applicator, ø 5 mm, rigid, length 320 mm

with adjustable spatula

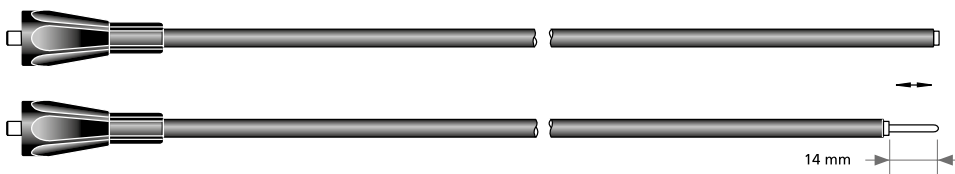

No. 20132-133



= 1

4.3 kVp

max 95 °C



30132-332

max 138 °C

APC applicator, ø 6 mm, flexible, length 100 mm



No. 20132-033



= 1

4.3 kVp

max 95 °C



30132-041

max 138 °C

APC applicator, ø 6 mm, flexible, length 200 mm



No. 20132-140



= 1

4.3 kVp

max 95 °C



30132-041

max 138 °C

APC applicator, ø 6 mm, tip flexible, length 320 mm

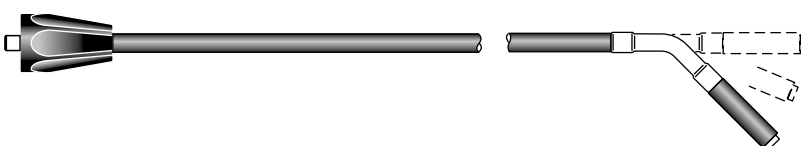

No. 20132-040



= 1

4.3 kVp

max 95 °C







30132-041

max 138 °C

Instruments for APC

APC applicators for APC handles

APC handles/irrigation adapters		Length	Piece	No.
VIO APC ReMode handle with 3 buttons for APC 2, with connecting cable, with instrument recognition		3 m	1	20132-200
VIO APC handle with 2 buttons for APC 2, with connecting cable, with instrument recognition		3 m	1	20132-201
APC handle with 2 buttons, APC 2/VIO, APC 300/ICC, with connecting cable, with instrument recognition		3 m	1	20132-043
Irrigation for adapter APC applicators with Luer-Lock, for APC applicators with APC handles			5	20132-087

APC handles and APC applicators, reusable
are not compatible with VIO 3/APC 3

APC ignition test adapters

APC ignition test adapter for VIO D/S, ICC, Standard (NE 6 mm)



No. 20183-070

 = 1

 max 95 °C

 30183-126

 max 134 °C

APC ignition test adapter for VIO D/S, ICC, International (NE 2-Pin)



No. 20183-071

 = 1

 max 95 °C

 30183-126



 max 138 °C

APC ignition test adapters
are not compatible with VIO 3/APC 3

Instruments for APC

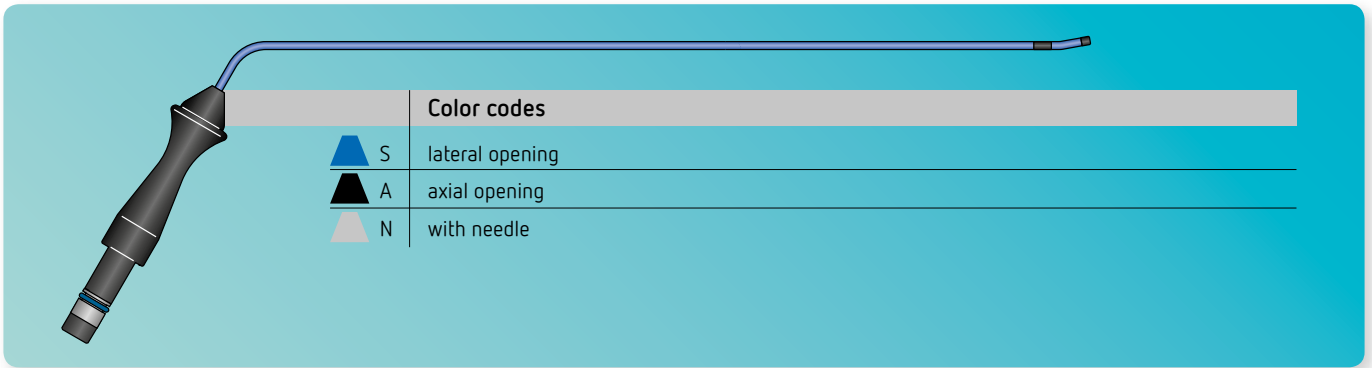



APC applicators for APC connecting cables, APC 2/APC 300

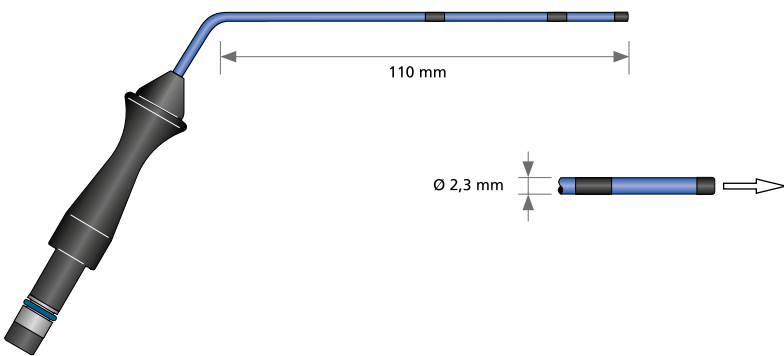

Color codes	
	S lateral opening
	A axial opening
	N with needle





APC applicator 110 A, \varnothing 2.3 mm, rigid, length 110 mm

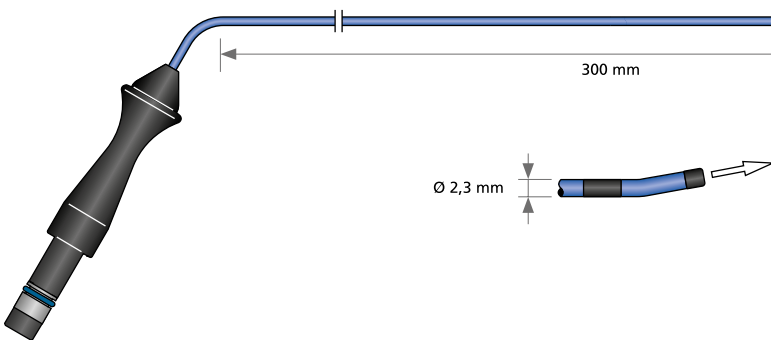

No. 20132-107	
 = 1	 4.3 kVp
	 max 95 °C
 30132-245	 max 138 °C





APC applicator 300 A, \varnothing 2.3 mm, rigid, length 300 mm

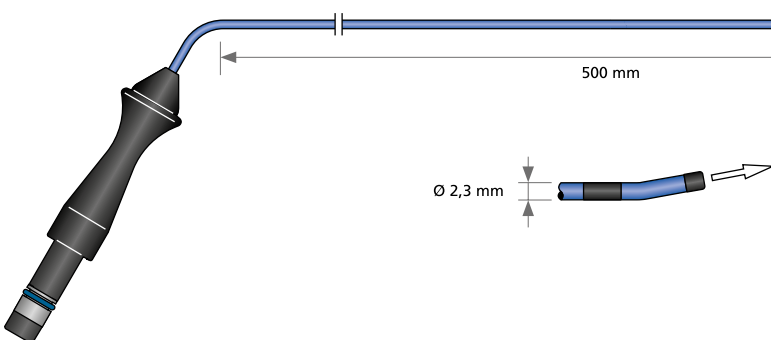

No. 20132-113	
 = 1	 4.3 kVp
	 max 95 °C
 30132-245	 max 138 °C

APC applicator 500 A, \varnothing 2.3 mm, rigid, length 500 mm



No. 20132-116	
 = 1	 4.3 kVp
	 max 95 °C
 30132-245	 max 138 °C

Instruments for APC

APC applicators for APC connecting cables, APC 2/APC 300

APC applicator 110 SC, \varnothing 2.3 mm, rigid, length 110 mm

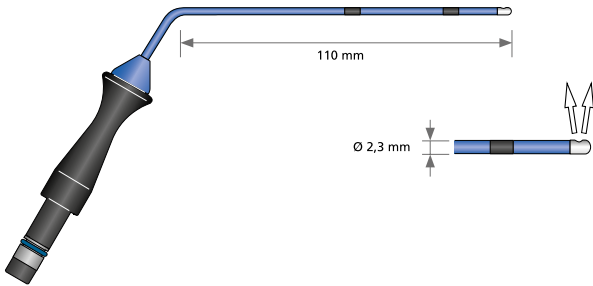

No. 20132-106

= 1

4.3 kVp

max 95 °C

30132-245

max 138 °C

Protection tongue for APC applicator 20132-106, elastic

silicone

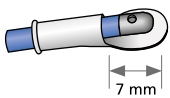

No. 20132-129

= 10

max 95 °C

30132-270

max 134 °C

APC applicator 240 SC, \varnothing 2.3 mm, rigid, length 240 mm

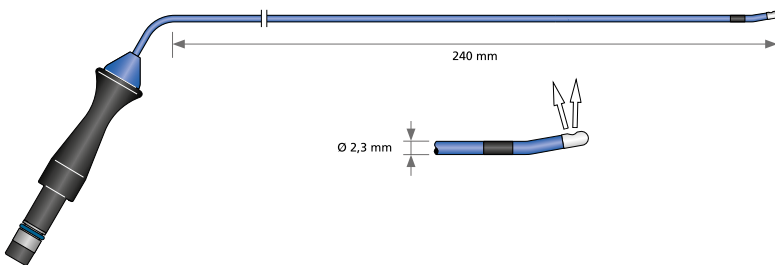

No. 20132-110

= 1

4.3 kVp

max 95 °C

30132-245

max 138 °C

APC applicator 110 N, \varnothing 2.3 mm, rigid, length 110 mm

with exposed needle 6 mm, e.g. for tonsillectomy

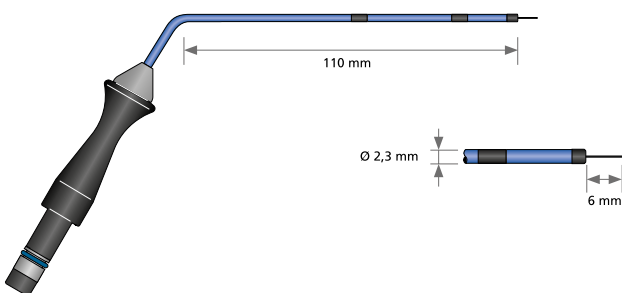

No. 20132-109

= 1

4.3 kVp

max 95 °C

30132-245

max 138 °C

APC connecting cable/irrigation adapter

Connecting cable for APC applicators,
APC 2/VIO, APC 300/ICC



Length

2.5 m

Piece

1

No.

20132-046

Irrigation adapter for APC applicators
with Luer Lock



Piece

5

20132-095

APC applicators, reusable
are not compatible with VIO 3/APC 3

Country-specific gas cylinder connectors APC 3, APC 2, APC 300

A

DIN 477, Nr. 6 m

for Afghanistan, Algeria, Andorra, Argentina **B***, Austria, Bangladesh **D***, Belgium, Bhutan, Brazil **B***, Brunei, Caribbean Countries, Chile **B***, China, Croatia, Cyprus, Czech Republic, Egypt, Estonia, France, Germany, Greece, Hungary, Iceland, India **D***, Indonesia, Iran, Ireland, Israel, Japan, Korea North, Korea South, Kuwait **D***, Latvia, Lebanon, Libya, Liechtenstein, Lithuania, Luxembourg, Macedonia, Malaysia, Malta, Mauritius, Morocco, Myanmar, Namibia, Nepal **D***, Oman **D***, Pakistan **D***, Peru **B***, Philippines, Poland, Portugal, Qatar **D***, Romania, Russia, Saudi Arabia **D***, Singapore, Slovakia, Slovenia, South Africa, Spain, Sri Lanka **D***, Sudan, Switzerland, Taiwan (ROC), Thailand **D***, Tunisia, Turkey, Ukraine, United Arab Emirates **D***, Uruguay, Vietnam **D***, Yemen **D***, Yugoslavia

B

CGA Nr. 580 m

for Argentina **A***, Bolivia, Brazil **A***, Canada, Chile **A***, Columbia, Dominican Republic, Ecuador, El Salvador, Guam, Guatemala, Haiti, Honduras, Italy, Mexico, New Zealand, Panama, Peru **A***, USA, Venezuela

C

DIN 477, Nr. 10 m

for Denmark, Finland, Ivory Coast, Netherlands, Norway, Sweden

D

BS 341, Nr. 3 m

for Australia, Bangladesh **A***, Great Britain, India **A***, Kuwait **A***, Nepal **A***, Northern Ireland, Oman **A***, Pakistan **A***, Qatar **A***, Saudi Arabia **A***, Sri Lanka **A***, Thailand **A***, United Arab Emirates **A***, Vietnam **A***, Yemen **A***

Accessories for APC

APC pressure reducers and argon gas cylinder / further APC accessories

Pressure reducer with sensor for APC 2/APC 3, with manual connection



gas cylinder connector to DIN 477 No. 6 m, W 21,8 outside, with hose 0,5 m with manual connection

No. 20134-004

= 1

30134-008

A

Argon gas cylinder, 5 liters, empty



gas cylinder connector to DIN 477 No. 6 m dimensions: height 60 cm, ø 14 cm weight 8,8 kg

No. 20132-171

= 1

A

Argon gas cylinder, 5 liters, 200 bar (2800 psi) filled with 4.8 argon gas (99,998%)



gas cylinder connector to DIN 477 No. 6 m dimensions: height 60 cm, ø 14 cm weight 10,7 kg

No. 20132-004

= 1

A

Pressure reducer with sensor for APC 2/APC 3, with manual connection



gas cylinder connector to CGA No. 580 m, 0,965" inside, with hose 0,5 m

No. 20134-002

= 1

30134-008

B

Argon gas cylinder, 5 liters, empty



gas cylinder connector to CGA No. 580 m dimensions: height 60 cm, ø 14 cm weight: 8,1 kg

No. 20132-165

= 1

B

Pressure reducer with sensor for APC 2/APC 3



No. 20134-006

= 1

30134-008

B

Accessories for APC

APC pressure reducers and argon gas cylinder / further APC accessories

Pressure reducer with sensor for APC 2/APC 3, with manual connection



gas cylinder connector to DIN 477 No. 10 m, W 24,32 outside, with hose 0,5 m with manual connection

No. 20134-001

= 1

30134-008

C

Pressure reducer with sensor for APC 2/APC 3, with manual connection



gas cylinder connector to BS 341 No. 3 m, G 5/8" inside, with hose 0,5 m, with manual connection

No. 20134-003

= 1

30134-008

D

Pressure reducer with sensor for APC 2/APC 3



No. 20134-005

= 1

30134-008

Japan

Pressure reducer with sensor for APC 2/APC 3, with manual connection



gas cylinder connector to ISO 5145 n°4, with hose 0.75 m

No. 20134-007

= 1

D130245

France

Pressure reducer without sensor for APC 300, with manual connection



gas cylinder connector to ISO 5145 n°4, with hose 0,75 m

No. 20132-078

= 1

D130245

France

Connecting tube for central gas supply, APC 2/APC 3, APC 300, length 1 m



No. 20132-085

= 1

Important information

We have prepared this document with care. Nonetheless, we cannot completely rule out errors in this document.

The information, recommendations and other data ("Information") contained in this document reflect our state of knowledge and the state of science and technology at the time of preparing the document. The information is of a general nature, non-binding and serves solely for general information purposes and does not represent instructions for use or notes on application.

The information and recommendations contained in this document do not constitute any legal obligations by Erbe Elektromedizin GmbH as well as their associated companies ("Erbe") or any other claims against Erbe. The information does not represent a guarantee or other quality statement, these require the express contractual arrangement with Erbe in individual cases.

Erbe shall not be liable for any type of damage resulting from following information given in this document, regardless of the legal reason for liability.

Every user of an Erbe product is responsible for checking the respective Erbe product for its properties as well as the suitability for the intended type of application or intended purpose in advance. The suitable type of application of the respective Erbe product is given by the user manual and the notes on use for the corresponding Erbe product. The user is obliged to check whether the existing user manual and the notes on use correspond with the status for the specific Erbe product. The devices may only be used according to the user manual and the notes on use.

The information on setting values, application sites, duration of application and the use of the respective Erbe product is based on the clinical experience of physicians independent from Erbe. They represent guidelines which need to be checked by the user for their suitability for the actual planned application. Depending on the circumstances of an actual application case, it may be necessary to deviate from the information provided. The user has to check this on his/her own responsibility in each case when using an Erbe product. We wish to point out that science and technology is constantly subject to new developments arising from research and clinical experience. For this reason it may be necessary for the user to deviate from the information provided in this document.

This document contains information about Erbe products which may possibly not be approved in a specific country. The user of the respective Erbe product is obliged to inform him/herself whether the Erbe product he/she is using is legally approved in his/her country and/or if legal requirements or restrictions for use possibly exist and to which extent.

This document is not intended for users in the USA.

Erbe Elektromedizin GmbH
Waldhoernlestrasse 17
72072 Tuebingen
Germany

Phone +49 7071 755-0
Fax +49 7071 755-179
info@erbe-med.com
erbe-med.com



**Instruments
and accessories**

for cryosurgery

Legend

Important notes

The authors and Erbe Elektromedizin GmbH have taken the greatest possible care while compiling the catalogue with electrosurgical accessories. Nevertheless, it is impossible to exclude the possibility that errors may be contained herein.

The information and recommendations given here may not be construed as constituting any basis for any claims against Erbe Elektromedizin GmbH. Should legal regulations stipulate liability, such liability shall be limited to intentional misconduct or gross negligence.

The data on the use of instruments is based on clinical experience. Medical science is subject to a process of permanent change based on research and clinical experience. Therefore the products are subject to alterations in design and technique. Because of production tolerances dimensions in the catalogue may marginally differ.

We confirm that none of our products contain latex, except the rubber straps, Art. No. 20592-009 and 20592-011.

Further product information

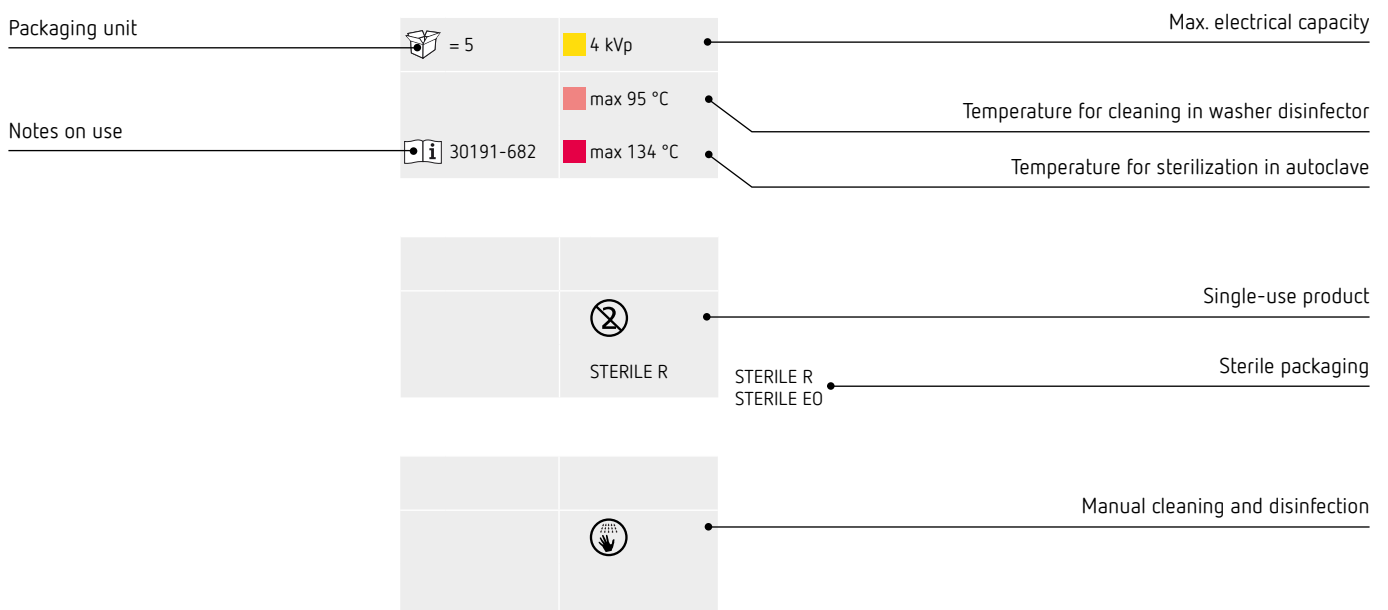

Please read carefully the corresponding notes on use before using any instrument.

Cryosurgery

Instruments and accessories

04	Gas bottle adapter CO ₂	09	Cryoprobes for ERBOKRYO CA
05	Flexible cryoprobes for ERBECRYO 2, single-use	10	Accessories for ERBOKRYO CA/ERBOKRYO AE
06	Flexible cryoprobes for ERBECRYO 2, reusable		
07	Accessories for ERBECRYO 2		

Overview

Instruments

Flexible cryoprobes



Cryosurgical unit

ERBECRYO 2



ERBOKRYO CA



Instruments and accessories

Gas bottle adapter CO₂

Country-specific gas cylinder connectors

Code letter	E			F	G	H	I
Thread type / Country	W 2.8 x 1/14"	W 21.7 x 1/14"	0.860" x 14 TPI	0.830"-14 NGO	G 3/4"	Pin Index	W 27 x 2 mm
Standard	Whitworth thread DIN 477 no. 9 (ø x pitch)	French standard for gases NFE 29-650	B. S. 341 British standard Threads per inch = pitch in threads/inch	CGA no. 320 Compressed Gas Association National Gas Outlet Straight Threads (ø x pitch)	British Whitworth pipe thread DIN ISO 228-1 (ø in inches)	Kodierung 1&6 DIN EN ISO 407	ISO 5145 no. 17
Gas bottle adapter	20410-003			20402-060	20410-016	20410-011	20402-061
Switch valve for connecting two gas cylinder adapters	20402-052						

Austria	Algeria	Australia	Argentina	Belarus	Canada	Denmark
Belarus	Angola	Brunei	Bolivia	Czech Republic	Cuba	Finland
Belgium	Belarus	Ecuador	Brazil	Egypt	France	Iceland
Bulgaria	Ethiopia	Egypt	Costa Rica	Russia	Great Britain	Italy
China	France	Hongkong	Guatemala	Slovakia	The Netherlands	Norway
ex. Yugoslavia	Guinea	India	Mexico	Ukraine	USA	Sweden
Finland	Lebanon	Indonesia	Peru	Venezuela	Venezuela	
Germany	Morocco	Iraq	Thailand			
Greece	Portugal	Ireland				
Hungary	Russia	Jordan				
Israel	Somalia	Kenya				
Korea	Spain	Kuwait				
Poland	Swiss	Liberia				
Russia	Syria	Libya				
Sweden	Tunisia	Malaysia				
Ukraine	Ukraine	Malta				
		New Zealand				
		Nigeria				
		Pakistan				
		Saudi Arabia				
		Singapore				
		South Africa				
		Sri Lanka				
		UAE				
		Vietnam				
		Yemen				

Instruments and accessories

Cryoprobes for ERBECRYO 2

Flexible cryoprobe, single-use, \varnothing 1.1 mm, length 1150 mm, with overshath, length 817 mm
with overshath \varnothing 2.6 mm, length 817 mm



No. 20402-401

= 5

30402-406



STERILE EO

Flexible cryoprobe, single-use, \varnothing 1.1 mm, length 1150 mm with overshath, length 757 mm
with overshath \varnothing 2.6 mm, length 757 mm



No. 20402-402

= 5

30402-406



STERILE EO

Flexible cryoprobe, single-use, \varnothing 1.7 mm, length 1150 mm



No. 20402-410

= 5

30402-406



STERILE EO

Flexible cryoprobe, single-use, \varnothing 2.4 mm, length 1150 mm



No. 20402-411

= 5

30402-406



STERILE EO

Instruments and accessories

Cryoprobes for ERBECRYO 2

Cryoprobe, flexible, \varnothing 2.4 mm, length 900 mm

for pulmonology



No. 20402-032



 30402-402

 max 95 °C

 max 138 °C

Cryoprobe, flexible, \varnothing 1.9 mm, length 900 mm

for pulmonology



No. 20402-037



 30402-402

 max 95 °C

 max 138 °C

Cryoprobe, flexible, \varnothing 1.9 mm, length 1150 mm

for pulmonology



No. 20402-040



 30402-402

 max 95 °C

 max 138 °C

Instruments and accessories

Accessories for ERBECRYO 2

One-pedal foot switch for ERBECRYO 2, AP & IP X8 equipment



No. 20402-200

= 1

max 75 °C

30402-231



Extension cable for ERBECRYO 2 footswitch, length 0.4 m



No. 20402-202

= 1



ERBECRYO 2 Cart



No. 20402-300

= 1



Wire basket, 339 x 100/155 x 205 mm (W x H x D)



No. 20180-010

= 1



Instruments and accessories

Accessories for ERBECRYO 2

Accessories for ERBECRYO 2	No.
Gas hose for ERBOKRYO CA / ERBOKRYO AE / ERBECRYO 2, length 1 m	20410-004
Gas hose for ERBOKRYO CA / ERBOKRYO AE / ERBECRYO 2, length 0.7 m	20448-000
Gas bottle adapter E, CO ₂ , W 21.8 x 1/14" / W 21.7 x 1/14" / 0.860" x 14 TPI	20410-003
Gas bottle adapter F, CO ₂ , 0.830"-14 NGO	20402-060
Gas bottle adapter G, CO ₂ , G 3/4"	20410-016
Gas bottle adapter H, CO ₂ , Pin Index	20410-011
Gas bottle adapter I, CO ₂ , W 27 x 2 mm	20402-061
Switching valve, CO ₂	20402-052
Exhaust gas hose for ERBECRYO 2, length 5 m Inner diameter 13 mm, outer diameter 18 mm	20402-007
Exhaust gas hose for ERBECRYO 2, length 10 m Inner diameter 13 mm, outer diameter 18 mm	20402-008

Instruments and accessories

Cryoprobes for ERBOKRYO CA

Cryoprobe, flexible, \varnothing 2.4 mm, length 900 mm

for pulmonology

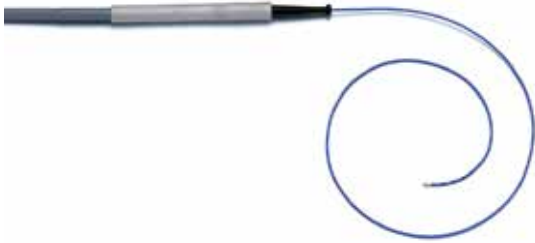

No. 20416-032

= 1

max 95 °C

30416-158

max 134 °C

Cryoprobe, flexible, \varnothing 1.9 mm, length 900 mm

for pulmonology

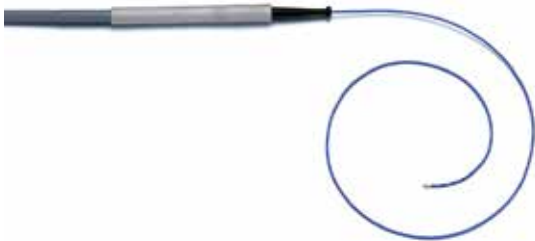

No. 20416-037

= 1

max 95 °C

30416-158

max 134 °C

Connecting adapter for flexible cryoprobes

for ERBOKRYO CA and AE



No. 20416-034

= 1

30416-157



Instruments and accessories

Accessories for ERBOKRYO CA / ERBOKRYO AE

Accessories for ERBOKRYO CA / ERBOKRYO AE	No.
One-pedal foot switch, explosion-protected	20711-008
One-pedal foot switch, not explosion-protected	20711-009
Gas hose for ERBOKRYO CA / ERBOKRYO AE / ERBECRYO 2, length 0.7 m	20448-000
Gas hose for ERBOKRYO CA / ERBOKRYO AE / ERBECRYO 2, length 1 m	20410-004
Gas filter for CO ₂ (Germany)	20410-010
Gas filter for CO ₂ , CIS, G 3/4"	20410-017
Gas filter, N ₂ O, R 3/8"	20410-006
Filter cartridges for gas filter N ₂ O R 3/8"	20410-008
Gas bottle adapter E, CO ₂ , W 21.8 x 1/14" / W 21.7 x 1/14" / 0.860" x 14 TPI	20410-003
Gas bottle adapter F, CO ₂ , 0.830"-14 NGO	20402-060
Gas bottle adapter G, CO ₂ , G 3/4"	20410-016
Gas bottle adapter H, CO ₂ , Pin Index	20410-011
Gas bottle adapter I, CO ₂ , W 27 x 2 mm	20402-061
Gas bottle adapter, N ₂ O, R 3/8"	20410-001
Gas bottle adapter, N ₂ O, 11/16" x 20	20410-002
Gas bottle adapter, N ₂ O, Pin Index	20410-005
Gas bottle adapter, N ₂ O, M 22 x 1.5	20410-013
Gas bottle adapter, N ₂ O, G 1/2"	20410-014
Gas bottle adapter, N ₂ O, M 26 x 1.5	20410-037



Important information

We have prepared this document with care. Nonetheless, we cannot completely rule out errors in this document.

The information, recommendations and other data ("Information") contained in this document reflect our state of knowledge and the state of science and technology at the time of preparing the document. The information is of a general nature, non-binding and serves solely for general information purposes and does not represent instructions for use or notes on application.

The information and recommendations contained in this document do not constitute any legal obligations by Erbe Elektromedizin GmbH as well as their associated companies ("Erbe") or any other claims against Erbe. The information does not represent a guarantee or other quality statement, these require the express contractual arrangement with Erbe in individual cases.

Erbe shall not be liable for any type of damage resulting from following information given in this document, regardless of the legal reason for liability.

Every user of an Erbe product is responsible for checking the respective Erbe product for its properties as well as the suitability for the intended type of application or intended purpose in advance. The suitable type of application of the respective Erbe product is given by the user manual and the notes on use for the corresponding Erbe product. The user is obliged to check whether the existing user manual and the notes on use correspond with the status for the specific Erbe product. The devices may only be used according to the user manual and the notes on use.

The information on setting values, application sites, duration of application and the use of the respective Erbe product is based on the clinical experience of physicians independent from Erbe. They represent guidelines which need to be checked by the user for their suitability for the actual planned application. Depending on the circumstances of an actual application case, it may be necessary to deviate from the information provided. The user has to check this on his/her own responsibility in each case when using an Erbe product. We wish to point out that science and technology is constantly subject to new developments arising from research and clinical experience. For this reason it may be necessary for the user to deviate from the information provided in this document.

This document contains information about Erbe products which may possibly not be approved in a specific country. The user of the respective Erbe product is obliged to inform him/herself whether the Erbe product he/she is using is legally approved in his/her country and/or if legal requirements or restrictions for use possibly exist and to which extent.

This document is not intended for users in the USA.

Erbe Elektromedizin GmbH
Waldhoernlestrasse 17
72072 Tuebingen
Germany

Phone +49 7071 755-0
info@erbe-med.com
erbe-med.com
medical-videos.com



Instruments and accessories

for hydrosurgery



Legend

Important notes

The authors and Erbe Elektromedizin GmbH have taken the greatest possible care while compiling the catalogue with electrosurgical accessories. Nevertheless, it is impossible to exclude the possibility that errors may be contained herein.

The information and recommendations given here may not be construed as constituting any basis for any claims against Erbe Elektromedizin GmbH. Should legal regulations stipulate liability, such liability shall be limited to intentional misconduct or gross negligence.

The data on the use of instruments is based on clinical experience. Medical science is subject to a process of permanent change based on research and clinical experience. Therefore the products are subject to alterations in design and technique. Because of production tolerances dimensions in the catalogue may marginally differ.

We confirm that none of our products contain latex, except the rubber straps, Art. No. 20592-009 and 20592-011.

Further product information

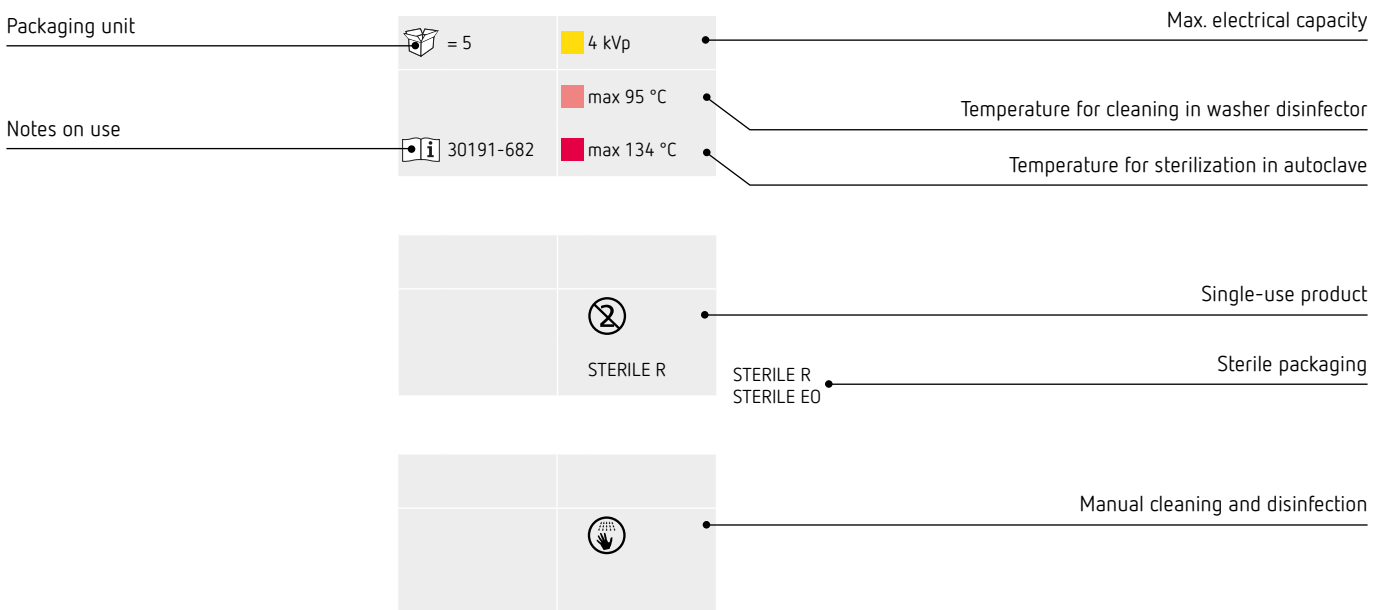

Please read carefully the corresponding notes on use before using any instrument.

Hydrosurgery

Instruments and accessories

- 04 Hybrid instruments
- 06 Applicators and probes
- 08 Accessories for ERBEJET 2
- 09 Accessories for ESM 2
- 11 Carts and accessories

Overview

Applicator



Generation of pressure



Activation



Workstation



Instruments and accessories

Hybrid instruments

HybridKnife, T-type, full-stream, \varnothing 2.3 mm, length 1.9 m

with connecting plug international (3-Pin)



No. 20150-060

= 5

2.5 kVp

30150-116



STERILE EO

HybridKnife, I-type, full-stream, \varnothing 2.3 mm, length 1.9 m

with connecting plug international (3-Pin)



No. 20150-061

= 5

2.5 kVp

30150-116



STERILE EO

HybridKnife, O-type, full-stream, \varnothing 2.3 mm, length 1.9 m

with connecting plug international (3-Pin)



No. 20150-062

= 5

0.99 kVp

30150-116



STERILE EO

Instruments and accessories

Hybrid instruments

HybridAPC, \varnothing 2.3 mm, length 1.9 m



No. 20150-015

= 5

4.3 kVp

30150-147



STERILE EO

Applicator, straight, with monopolar electro-surgical function, \varnothing 6 mm, length 80 mm

with suction, e.g. for liver surgery



No. 20150-036

= 4

2.5 kVp

30150-205



STERILE EO

Instruments and accessories

Applicators and probes

Applicator, curved tip, \varnothing 5 mm, length 183 mm

e.g. for urology



No. 20150-025



 30150-000



STERILE EO

Applicator, curved tip, \varnothing 5 mm, length 336 mm

e.g. for laparoscopy



No. 20150-026



 30150-000



STERILE EO

Applicator, straight, \varnothing 6 mm, length 65 mm

with suction, e.g. for liver surgery



No. 20150-030



 30150-000



STERILE EO

Applikator, flexible tip, \varnothing 6 mm, length 65 mm

with suction, e.g. for liver surgery



No. 20150-031



 30150-000



STERILE EO

Applicator, straight, \varnothing 6 mm, length 306 mm

with suction, e.g. for TME



No. 20150-038



 30150-000



STERILE EO

Instruments and accessories

Applicators and probes

Applicator, straight, \varnothing 6 mm, length 180 mm

with suction, e.g. for TEM



No. 20150-039

 = 5

 30150-000



STERILE EO

Applicator, bayonet, \varnothing 2.8 mm, length 90 mm

with suction



No. 20150-041

 = 5

 30150-000



STERILE EO

Flexible probe, \varnothing 1.3 mm, length 2.2 m

e.g. for flexible endoscopy



No. 20150-020

 = 5

 30150-000



STERILE EO

Instruments and accessories

Accessories for ERBEJET 2

Pump (single-use)



No. 20150-300

= 5

30150-055

E0

Pump cartridge plus for ERBEJET 2



No. 20150-301

= 5

30150-400

STERILE E0

ERBEJET 2 one-pedal foot switch with ReMode, AP & IP X8 equipment



No. 20150-101

= 1

30150-100

max 75 °C



ERBEJET 2 two-pedal foot switch with ReMode, AP & IP X8 equipment



No. 20150-100

= 1

30150-100

max 75 °C



Further accessories for foot switches	Piece	No.
Hoop guard for VIO two-pedal foot switch	1	20189-306
Cable for ERBEJET 2 foot switch, length 5 m	1	20150-104

Power cord	Country	Length	Piece	No.
Power cord 10A	Germany	0.5 m	1	51704-046
Power cord 10A	Germany	2.5 m	1	51704-037
Power cord 10A	Germany	4 m	1	51704-032
Power cord 10A	Germany	5 m	1	51704-042
Power cord 10A	Great Britain	2.5 m	1	51704-038
Power cord 10A	Great Britain	5 m	1	51704-043
Power cord 10A	Italy	2.5 m	1	51704-040
Power cord 10A	Italy	5 m	1	51704-045
Power cord 10A	Canada	4 m	1	51704-039
Power cord 10A	India	4 m	1	20128-004

Instruments and accessories

Accessories for ESM 2

Suction container, 1.5 liters



for use with suction bag 20340-012

No. 20340-102

 = 1

Suction bag, 1.5 liters



for use with suction container 20340-102

No. 20340-012

 = 30



Suction bag, 2.5 liters



for use with suction container 20340-103

No. 20340-013

 = 30



Instruments and accessories

Accessories for ESM 2

ESM membrane filter



for use with silicone hose 20340-004

No. 20340-100

= 10



Silicone hose, length 600 mm



No. 20340-004

= 1

max 95 °C

max 134 °C

Rail bracket, plastic



for use with suction container 20340-102 and 20340-103

No. 20340-002

= 1

max 95 °C

max 134 °C

Switching valve, rail bracket and 2 silicone hoses, length 300 mm



No. 20340-003

= 1

max 95 °C

max 134 °C

Connecting cable

ECB connecting cable for ERBEJET 2, length 0.45 m

No.

51709-008

Fastening set

Fastening set EIP 2 / ESM 2 to VIO CART 20180-000

No.

20180-135

Instruments and accessories

Carts and accessories

VIO CART, system carrier for VIO family and modules



dimensions: 630 x 940 x 650 mm (WxHxD)
 weight: 31 kg
 4 conductive castors \varnothing 100 mm, with fixing brake
 1 power input
 3 power outlets

incl. following accessories:
 1 grab handle out of stainless steel
 2 cable holders
 1 foot switch bracket (for currently available foot switches)

No. 20180-000

= 1

80180-018



Hook for irrigation liquid bag on bracket / VIO Cart



No. 20325-002

= 1

max 95 °C

max 134 °C

Upper bracket for VIO CART, length 260 mm



No. 20180-040

= 1



Lower bracket for VIO CART, length 390 mm

for use with secretion suction

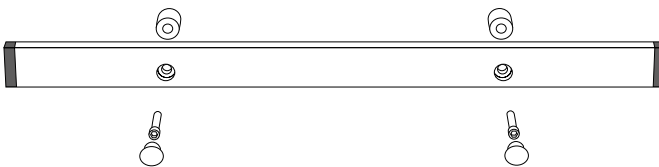

No. 20180-042

= 1



Fastening sets

Fastening set VIO D/S / APC 2 / NT 2 / VEM 2 / ERBEJET 2 on VIO CART 20180-000

No. 20180-131

Fastening set EIP 2 / ESM 2 to VIO CART 20180-000

No. 20180-135

Fastening set on ERBEJET 2, connection to VIO / APC 2 / VEM 2 / NT 2

No. 20150-050

Important information

We have prepared this document with care. Nonetheless, we cannot completely rule out errors in this document.

The information, recommendations and other data ("Information") contained in this document reflect our state of knowledge and the state of science and technology at the time of preparing the document. The information is of a general nature, non-binding and serves solely for general information purposes and does not represent instructions for use or notes on application.

The information and recommendations contained in this document do not constitute any legal obligations by Erbe Elektromedizin GmbH as well as their associated companies ("Erbe") or any other claims against Erbe. The information does not represent a guarantee or other quality statement, these require the express contractual arrangement with Erbe in individual cases.

Erbe shall not be liable for any type of damage resulting from following information given in this document, regardless of the legal reason for liability.

Every user of an Erbe product is responsible for checking the respective Erbe product for its properties as well as the suitability for the intended type of application or intended purpose in advance. The suitable type of application of the respective Erbe product is given by the user manual and the notes on use for the corresponding Erbe product. The user is obliged to check whether the existing user manual and the notes on use correspond with the status for the specific Erbe product. The devices may only be used according to the user manual and the notes on use.

The information on setting values, application sites, duration of application and the use of the respective Erbe product is based on the clinical experience of physicians independent from Erbe. They represent guidelines which need to be checked by the user for their suitability for the actual planned application. Depending on the circumstances of an actual application case, it may be necessary to deviate from the information provided. The user has to check this on his/her own responsibility in each case when using an Erbe product. We wish to point out that science and technology is constantly subject to new developments arising from research and clinical experience. For this reason it may be necessary for the user to deviate from the information provided in this document.

This document contains information about Erbe products which may possibly not be approved in a specific country. The user of the respective Erbe product is obliged to inform him/herself whether the Erbe product he/she is using is legally approved in his/her country and/or if legal requirements or restrictions for use possibly exist and to which extent.

This document is not intended for users in the USA.

Erbe Elektromedizin GmbH
Waldhoernlestrasse 17
72072 Tuebingen
Germany

Phone +49 7071 755-0
Fax +49 7071 755-179
info@erbe-med.com
erbe-med.com

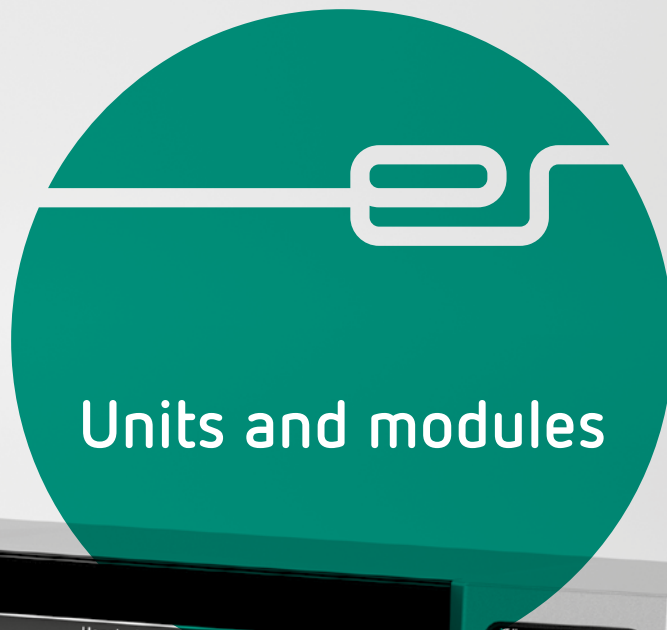

Units and modules



Legend

Important notes

The authors and Erbe Elektromedizin GmbH have taken the greatest possible care while compiling the catalogue with electrosurgical accessories. Nevertheless, it is impossible to exclude the possibility that errors may be contained herein.

The information and recommendations given here may not be construed as constituting any basis for any claims against Erbe Elektromedizin GmbH. Should legal regulations stipulate liability, such liability shall be limited to intentional misconduct or gross negligence.

The data on the use of instruments is based on clinical experience. Medical science is subject to a process of permanent change based on research and clinical experience. Therefore the products are subject to alterations in design and technique. Because of production tolerances dimensions in the catalogue may marginally differ.

We confirm that none of our products contain latex, except the rubber straps, Art. No. 20592-009 and 20592-011.

Further product information

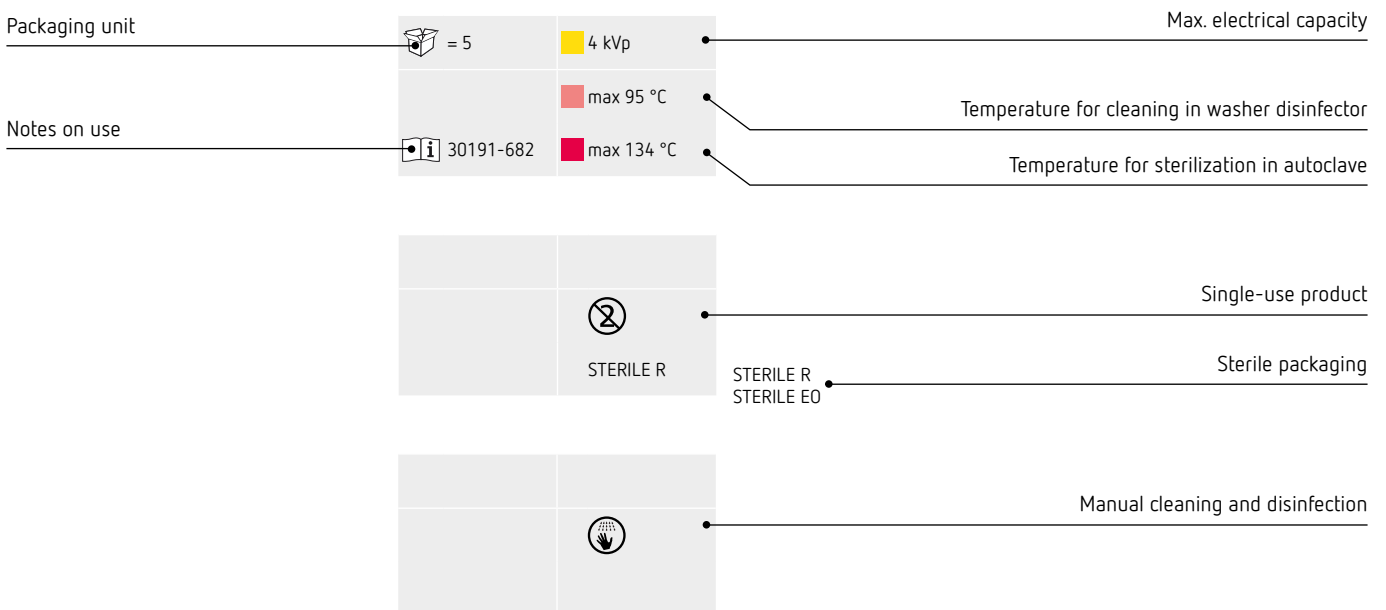

Please read carefully the corresponding notes on use before using any instrument.

Units and modules

Electrosurgery

- 04 VIO® 3 and socket modules
- 05 VIO® D, S, C and socket modules
- 09 Modes and Upgrades for VIO® D, S, C
- 10 Application areas
- 11 Modules

Plasmasurgery

- 13 Modules

Hydro-surgery

- 14 Units and modules

Cryosurgery

- 15 Units

VIO® 3
VIO® 300/200 D
VIO® 300/200 S
VIO® 100/50 C

APC 3
APC 2

IES 3
IES 2
EIP 2
VEM 2

ERBEJET® 2
ESM 2

ERBECRYO® 2

Electrosurgery

VIO® 3

VIO® 3

VIO® 3 is yet another of our milestones in technology following VIO® 300/200. Take advantage of the progress that using VIO® 3 provides you and your patients.

- Logical, convenient and visual operator guidance (stepGUIDE)
- ReMode: Up to 6 different settings selectable from the sterile field
- Reliable, reproducible tissue effects thanks to state-of-the-art processor technology
- Sockets: Easy replacement, connection recommendations, slot assignment



No. 10160-000

CUT	COAG
autoCUT	preciseSECT
highCUT	swiftCOAG
dryCUT	softCOAG
autoCUT bipolar	forcedCOAG
highCUT bipolar	sprayCOAG
endoCUT Q	twinCOAG
endoCUT I	softCOAG bipolar
	forcedCOAG bipolar
	thermoSEAL
	forcedAPC
	pulsedAPC
	preciseAPC

Socket modules for VIO® 3

Socket modules	No.
MF-U, as an upgrade kit	20160-005
MF-0, as an upgrade kit	20160-004
MO 3Pin-9/5, as an upgrade kit	20160-001
MO 3Pin-Bovie, as an upgrade kit	20160-002
BI 2Pin 22-28-8/4, as an upgrade kit	20160-003
NE 6 - NE 2Pin, as an upgrade kit	20160-006

Electrosurgery

VIO® D

VIO® 300 D

In addition to vessel sealing, the high-end unit from the VIO® product range offers all APC modes and all available CUT and COAG modes (either as a standard mode in the unit or as an upgrade)

- Simple and interactive operation using the TFT display
- Automatic power adjustment for all control technologies
- Variable configuration of socket assignment
- Additional upgrades available for specific medical specialties



No. 10140-100

Upgrades

PRECISE Upgrade - PRECISE CUT - BIPOLAR PRECISE CUT - PRECISE COAG - BIPOLAR PRECISE COAG	29140-217
ENDO CUT Upgrade - ENDO CUT Q - ENDO CUT I	29140-218
TWIN COAG Upgrade - TWIN COAG - Argon TWIN COAG	29140-216
BiClamp Upgrade	29140-214

VIO® 200 D

VIO® electrocautery unit for endoscopy and other disciplines with all APC modes and other COAG modes for endoscopy, ENDO CUT I and Q as an upgrade

- Simple and interactive operation using the TFT display
- Automatic power adjustment for all control technologies
- Variable configuration of socket assignment
- Additional upgrades available for specific medical specialties



No. 10140-200

Upgrades

PRECISE Upgrade - PRECISE CUT - BIPOLAR PRECISE CUT - PRECISE COAG - BIPOLAR PRECISE COAG	29140-217
ENDO CUT Upgrade - ENDO CUT Q - ENDO CUT I	29140-218
DRY CUT Upgrade - DRY CUT - Argon DRY CUT	29140-215

Electrosurgery

VIO® D

VIO® 300 S

Universal VIO® electrosurgical unit based on different variants. For many surgical specialities with the most important CUT and COAG modes as well as FORCED APC, with optional ENDO CUT I and Q

- Direct operation using the segment display
- Automatic power adjustment for all control technologies
- Variable configuration of socket assignment



No. 10140-300

Upgrades

ENDO CUT Upgrade - ENDO CUT Q - ENDO CUT I	29140-218
TWIN COAG Upgrade - TWIN COAG - Argon TWIN COAG	29140-216

VIO® 200 S

VIO® electrosurgical unit for many electrosurgical procedures and for specialist medical practices with the most important CUT and COAG modes as well as FORCED APC, with optional ENDO CUT I and Q

- Direct operation using the segment display
- Automatic power adjustment for all control technologies
- Variable configuration of socket assignment



No. 10140-400

Upgrades

ENDO CUT Upgrade - ENDO CUT Q - ENDO CUT I	29140-218
--	-----------

Electrosurgery

VIO® C

VIO® 100 C

VIO® compact electrosurgical unit for use in surgical practice with the most important CUT and COAG modes (100 watt unit)

No. 10140-500

- Direct operation using the segment display
- Monopolar cutting
- Monopolar and bipolar coagulation



VIO® 50 C

VIO® compact electrosurgical unit for use in surgical practice with the most important CUT and COAG modes (50 watt unit)

No. 10140-550

- Direct operation using the segment display
- Monopolar cutting
- Monopolar and bipolar coagulation



Electrosurgery

Socket modules for VIO® D, S and C

Bipolar sockets (BI)		No.
2Pin-22-28-8/4 mm		20140-613
Monopolar sockets (MO)		No.
3Pin-Bovie		20140-622
3Pin-9/5 mm		20140-623
Multifunctional socket (MF) for VIO® 300 D only		No.
multifunctional		20140-630
Neutral electrode sockets (NE)		No.
6 mm-2Pin		20140-642

Socket modularity						
	VIO® 300 D	VIO® 200 D	VIO® 300 S	VIO® 200 S	VIO® 100 C	VIO® 50 C
Slot 1	BI	BI	BI	BI	BI	BI
Slot 2	MO, BI, MF	MO, BI	MO	MO	MO	MO
Slot 3	MO, MF	MO	MO	MO	-	-
Slot 4	NE	NE	NE	NE	NE	NE

Electrosurgery

Modes and Upgrades for VIO® D, S, C

CUT	VIO® 300 D	VIO® 200 D	VIO® 300 S	VIO® 200 S	VIO® 50/100 C
AUTO CUT	■	■	■	■	■*
HIGH CUT	■	-	○	-	-
DRY CUT	■	□	○	-	■*
DRY CUT°	■	-	○	-	-
BIPOLAR CUT	■	■	○	-	-
BIPOLAR CUT +	■	-	-	-	-
BIPOLAR CUT ++	■	-	-	-	-
PRECISE CUT	□	□	-	-	-
BIPOLAR PRECISE CUT	□	□	-	-	-
ENDO CUT Q	□	□	□	□	-
ENDO CUT I	□	□	□	□	-
ARGON AUTO CUT	■	■	■	■	-
ARGON HIGH CUT	■	-	○	-	-
ARGON DRY CUT	■	□	○	-	-
ARGON DRY CUT°	■	-	○	-	-

COAG	VIO® 300 D	VIO® 200 D	VIO® 300 S	VIO® 200 S	VIO® 50/100 C
SOFT COAG	■	■	○	■	■*
SWIFT COAG	■	■	○	-	-
SWIFT COAG°	■	-	○	-	-
CLASSIC COAG	■	-	■	-	-
FORCED COAG	■	■	○	■	■*
SPRAY COAG	■	-	■	-	-
BIPOLAR SOFT COAG	■	■	■	■	■*
BIPOLAR SOFT COAG +	■	-	-	-	-
BIPOLAR SOFT COAG ++	■	-	-	-	-
BIPOLAR FORCED COAG	■	■	-	-	-
PRECISE COAG	□	□	-	-	-
BIPOLAR PRECISE COAG	□	□	-	-	-
TWIN COAG	□	-	□	-	-
BICLAMP	□	-	-	-	-
FORCED APC	■	■	■	■	-
PRECISE APC	■	■	-	-	-
PULSED APC	■	■	-	-	-
ARGON SOFT COAG	■	■	○	■	-
ARGON SWIFT COAG	■	■	○	-	-
ARGON SWIFT COAG°	■	-	○	-	-
ARGON FORCED COAG	■	■	○	■	-
ARGON TWIN COAG	□	-	□	-	-

Legend:

■ included
○ depending on the version

□ upgradeable
□ only available ex factory (must be ordered)

* modified modes,
power adjustment only

Electrosurgery

Application areas

	VIO® 3	VIO® 300 D	VIO® 200 D	VIO® 300 S	VIO® 200 S	VIO® 50/100 C
Gynecology	■	■	-	▣	-	▣
Urology	■	■	-	▣	-	■
General surgery	■	■	-	▣	-	■
Gastroenterology / Endoscopy	■	▣	■	▣	▣	-
Pulmonology	■	▣	■	▣	▣	-
ENT	▣	■	-	▣	-	■
Orthopedics	■	■	-	▣	-	■
Dermatology	■	■	-	-	▣	■
OMS	■	■	▣	▣	-	■
Ophthalmology	-	-	-	-	▣	■

For practices in hospitals and outpatient operations

Clinics/Practices

Legend:

- strongly recommended
- ▣ recommended

Modules

IES 3 Smoke evacuation unit, 100–240 V AC ($\pm 10\%$), without main filter cartridge

No. 10323-000

- Protection through ULPA-15 filter
- Good response, quiet operation
- Extended range of applications
- Flexible activation

The main filter cartridge is not included in the scope of delivery.



Main filter cartridge IES 3 with connection $\varnothing 22$ mm

No. 20323-000



 = 1



 80114-801

IES 2, smoke plume evacuation

No. 10322-000

Smoke plume evacuation with high suction capacity

- Manual activation, using footswitch or automatically for electrosurgical activation
- Variable assignment of suction programs
- Programmable values for CUT or COAG suction
- Basic suction and suction with run-on time
- Long filter operating time



Modules

EIP 2, irrigation pump for endoscopic procedures

Endoscopic irrigation pump for irrigating the target tissue

No. 10325-000

- Activation via footswitch or via the user interface on the unit
- 3 quick access options for irrigation level (30 %, 50 % and 80 % irrigation)
- Values can be changed individually and quickly
- Additional irrigation catheter often not required



VEM 2, VIO® extension module

Additional module for extended VIO® socket assignment

No. 10141-000

- 2 additional sockets can be connected to the VIO® electrosurgical unit
- As a result, more flexibility in selecting socket assignment

only for VIO® D/S



Modules

APC 3

No. 10135-000

The benefits of the logical and intuitive VIO® 3 interface are now also available with APC 3. As your stepGUIDE, the interface guides you through each menu, suggesting experienced starting settings for APC applications.

- All APC modes are integrated into the VIO® 3: pulsedAPC®, forcedAPC and preciseAPC®
- The APC socket – your connection for APC filtered instruments
- Besides the APC socket, an additional multifunctional socket is provided for further instruments. For the first time, this allows you to connect and use up to 6 instruments as required for your procedure.



only for VIO® 3

APC 2

No. 10134-000

Effective coagulation of bleeding, as well as devitalization of changes in tissue

- 3 APC modes: FORCED APC, PRECISE APC, PULSED APC (see table on page 9)
- Non-contact procedure, instrument tips cannot become clogged
- Even effects with coagulation and devitalization
- Good dosage accuracy, resulting in greater safety during application
- Low risk of perforation
- Argon-supported cutting
- Minimum carbonization, minimum development of smoke plume, good visibility of the target area



only for VIO® D/S

Hydrosurgery

Units and modules

ERBEJET® 2

Selective dissection of tissue, layer-specific elevation of tissue layers

No. 10150-000

- Basic module for hybrid technology
- Applications include general or abdominal surgery, gastroenterology, urology
- Protects blood vessels, nerves and organs
- High degree of tissue selectivity enables exposure and dissection of tissue layers
- Minimized bleeding, controlled management of bleeding



ESM 2, suction module

Suction module for the waterjet surgery unit (ERBEJET 2)

No. 10340-000

- Individual or automatic suction for waterjet application
- Clear view of the target operating area



Cryosurgery

Units

ERBECRYO® 2

No. 10402-000

Cryosurgical unit for cryobiopsy, recanalization and cryo-devitalization

- Application with flexible cryoprobes
- Superior tissue samples in terms of quality and quantity
- No crush artifacts or hemorrhages
- High diagnostic weighting
- Supports endobronchial and transbronchial biopsy
- Coolant: carbon dioxide (CO₂)



Important information

We have prepared this document with care. Nonetheless, we cannot completely rule out errors in this document.

The information, recommendations and other data („Information“) contained in this document reflect our state of knowledge and the state of science and technology at the time of preparing the document. The information is of a general nature, non-binding and serves solely for general information purposes and does not represent instructions for use or notes on application.

The information and recommendations contained in this document do not constitute any legal obligations by Erbe Elektromedizin GmbH as well as their associated companies („Erbe“) or any other claims against Erbe. The information does not represent a guarantee or other quality statement, these require the express contractual arrangement with Erbe in individual cases. Erbe shall not be liable for any type of damage resulting from following information given in this document, regardless of the legal reason for liability.

Every user of an Erbe product is responsible for checking the respective Erbe product for its properties as well as the suitability for the intended type of application or intended purpose in advance. The suitable type of application of the respective Erbe product is given by the user manual and the notes on use for the corresponding Erbe product. The user is obliged to check whether the existing user manual and the notes on use correspond with the status for the specific Erbe product. The devices may only be used according to the user manual and the notes on use.

The information on setting values, application sites, duration of application and the use of the respective Erbe product is based on the clinical experience of physicians independent from Erbe. They represent guidelines which need to be checked by the user for their suitability for the actual planned application. Depending on the circumstances of an actual application case, it may be necessary to deviate from the information provided. The user has to check this on his/her own responsibility in each case when using an Erbe product. We wish to point out that science and technology is constantly subject to new developments arising from research and clinical experience. For this reason it may be necessary for the user to deviate from the information provided in this document.

This document contains information about Erbe products which may possibly not be approved in a specific country. The user of the respective Erbe product is obliged to inform him/herself whether the Erbe product he/she is using is legally approved in his/her country and/or if legal requirements or restrictions for use possibly exist and to which extent.

This document is not intended for users in the USA.

Erbe Elektromedizin GmbH
Waldhoernlestrasse 17
72072 Tuebingen
Germany

Phone +49 7071 755-0
Fax +49 7071 755-179
info@erbe-med.com
erbe-med.com